

Product catalogue

valid from 01. April 2025



More than just pumps



Accessories

of drum and progressive cavity pumps

- for use in hazardous areas
- for use in non hazardous areas
- for use in hazardous and non hazardous areas

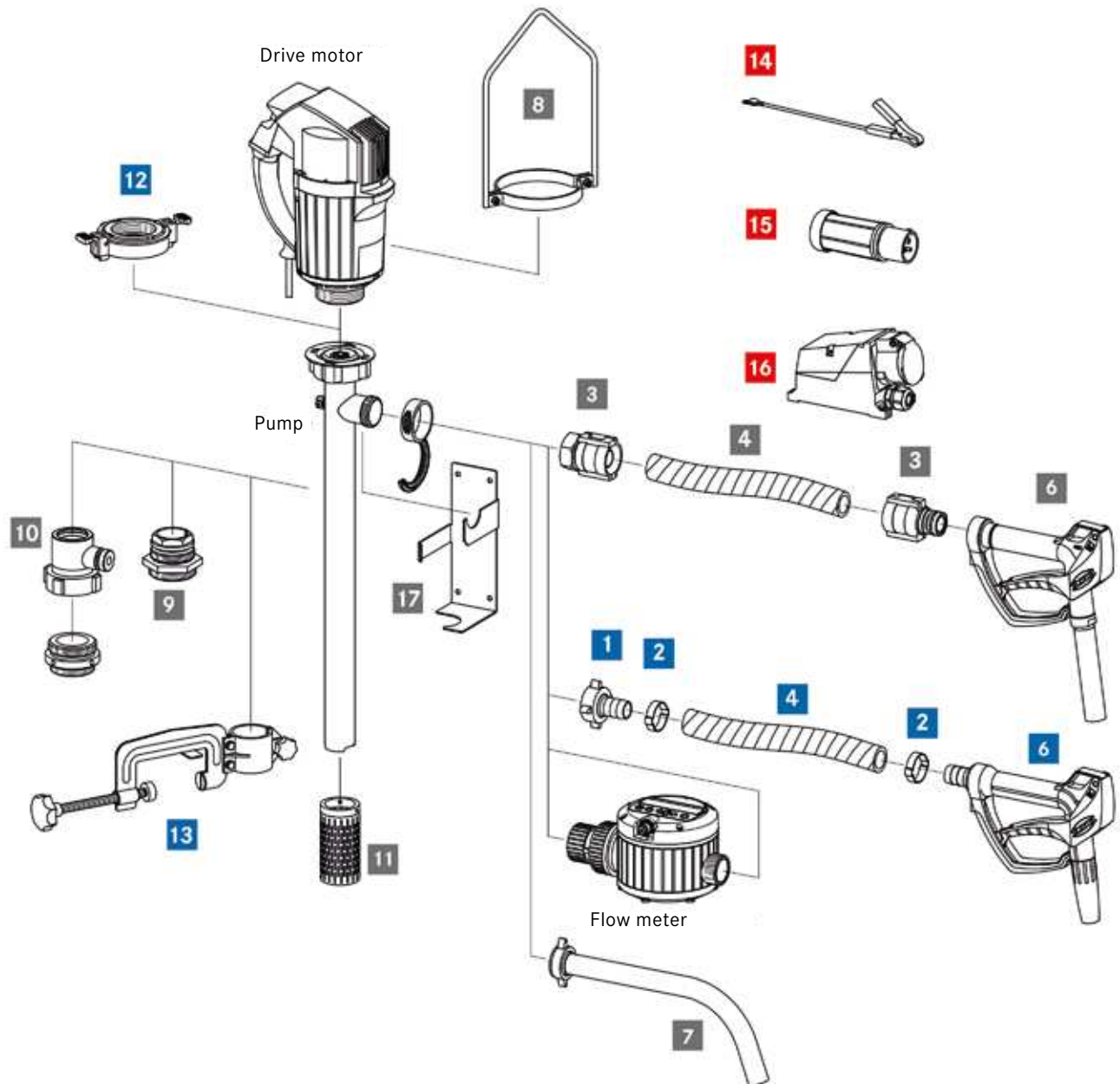

		Page			Page
■ 1	Hose connection	14, 22, 25, 26, 27, 39, 47, 49	■ 10	FLUX fume gland	36, 48
■ 2	Hose clip	14, 32	■ 11	Suction strainer	37, 48
■ 3	Swaged hose fitting	28, 29, 30, 49, 59	■ 12	Quick action coupling	37
■ 4	Hose	31, 32, 59	■ 13	Attachment clamp	38, 48
■ 5	Hose kit (3+4 = hose kit)	30, 31	■ 14	Earth (ground) wire	18, 19, 43, 44, 52
■ 6	Hand nozzle	14, 33, 34, 39	■ 15	Explosion-proof plug	18, 43, 52
■ 7	Discharge spout	37, 39, 48, 49, 59	■ 16	Explosion-proof socket	18, 43, 52
■ 8	Carrying handle	18, 43, 50, 51, 52	■ 17	Wall bracket	38
■ 9	Compression gland	37, 48			

Drum and container pumps

Pump kits

5-10

JUNIORFLUX / COMBIFLUX (series 300) and accessories

11-14

For low volumes

F 310 with mechanical seal, F 314 sealless

Motors and accessories

15-19

Commutator motors FEM 4070, F 457, F 458, F 460 Ex

Brushless motor FBM 4000 Ex

Three-phase gear motor F 414

Air-operated motors F 416 Ex, F 416-1 Ex, F 416-2 Ex

Drum and container pumps (series 400)

20-26

F 424 the sealless, F 425 for 99,98 % drum emptying

F 426 the mixing pump, F 427 can be taken apart completely

F 430 with mechanical seal, drum pumps in special lengths

Accessories

27-39

Hose connections, hose couplings,

swaged hose fittings, hose kits,

hoses, 1-Ear hose clips,

hand nozzles, discharge unit, fume glands,

compression glands, outlet tubes, discharge spouts,

suction strainers, attachment clamps,

mixing tubes, flow back stop valves,

accessories in FOOD version

Progressive cavity pumps, motors and accessories

41-53

Progressive cavity pumps F 570 and F 580

Progressive cavity pumps horizontal / for dry installation (TR)

Accessories and accessories in FOOD version

Tools for assembly/disassembly

VISCOFLUX drum emptying systems

55-60

Flow meters with FLUXTRONIC® and accessories

61-73

Nutating disc type FMC 100, FMJ 100, FMC 250

Oval rotor type FMO 101 – FMO 150

Air-operated diaphragm pumps and accessories

Solid construction

75-80

RFM 10, RFML 10, RFM 15, RFML 15,

RFM 25, RFML 25, RFM 40

Moulded pump design

81-86

FDM 07, FDM 10, FDM 12, FDM 25

FDM 40, FDM 50, FDM 80, FDMH 25

Certificates

87

Pump kits

F 300

F 400

F 500

VISCOFLUX

Flow
meter

RFM
FDM





Errors and changes excepted.

Certificates and conformities

Certificates and Conformities

The right solution for every industry

Certified safety for the most widest range of industries and countries: FLUX products have been developed and certified for use around the world; they comply with the highest demands and safety standards. With FLUX you are always on the safe side everywhere.

<p>All FLUX products conform to pertinent fundamental health & safety regulations of the EC Machinery Directive 2006/42/EC and are therefore CE certified. They also have the UKCA approval for the British market.</p>	
<p>Dependent on version, FLUX motors are available with VDE GS, UL or also CSA test certification.</p>	
<p>For usage in pharmaceutical, food and cosmetics industries there are the following products available:</p> <ul style="list-style-type: none"> • pumps with 3A certification • FLUX FOOD pumps conform to EC 1935/2004, suitable for contact with food • products conform to FDA CFR 21 	
<p>For usage in hazardous areas there are FLUX products available with explosion protection, built and certified according to ATEX Directive 2014/34/EU.</p>	

To learn more about our product range contact your local sales partner or go to www.flux-pumps.com



Pump kits

Pump kit "JUNIORFLUX" for low volumes

Pump with fixed motor

drum pump in polypropylene, sealless, with hastelloy C shaft, **commutator motor F 310**, 230-240 V, 50-60 Hz, 230 watt (with integral motor) and hand nozzle PP

- JUNIORFLUX **F 314 PP-25/19** PVC hose DN 13, 1,5 m long

	immersion length	part no.	
for canister emptying	700 mm	10-31443007	●
for drum emptying	1.000 mm	10-31443010	●

- JUNIORFLUX **F 314 PP-32/25** PVC hose DN 19, 1,5 m long

	immersion length	part no.	
for drum emptying	1.000 mm	10-31444010	●



Pump kit "JUNIORFLUX AdBlue®" * for low volumes

drum pump JUNIORFLUX **F 314 PP/S-32/25** in polypropylene, with stainless steel shaft, sealless, **commutator motor F 310**, 230-240 V, 50-60 Hz, 230 watt (with integral motor), PVC hose DN 19, 2 m with hand nozzle PP AdBlue® * version with small outlet Ø 19 mm

	immersion length	part no.	
for drum emptying	1.000 mm	10-31444ZV2	●



Pump kit "COMBIFLUX" for low volumes with removable battery motor

drum pump in polypropylene, sealless, hastelloy C shaft, brushless DC, **battery motor FBM-B 3100**, includes 18 V Li-Ion battery, charger 220-240 V, 50-60 Hz, with hand nozzle PP

- COMBIFLUX **FP 314 PP-25/19**, PVC hose DN 13, 1,5 m long

	immersion length	part no.	
for canister emptying	700 mm	10-31448807	●
for drum emptying	1.000 mm	10-31448810	●

- COMBIFLUX **FP 314 PP-32/25**, PVC hose DN 19, 1,5 m long

	immersion length	part no.	
for drum emptying	1.000 mm	10-31449910	●



drum pump in polypropylene, sealless, hastelloy C shaft, brushless DC, **battery motor FBM-B 3100**, includes 18 V Li-Ion battery, charger 100-120 V, 50-60 Hz, with hand nozzle PP

- COMBIFLUX **FP 314 PP-25/19**, PVC hose DN 13, 1,5 m long

	immersion length	part no.	
for drum emptying	1.000 mm	10-31448910	●

Pump kit „COMBIFLUX AdBlue®" * for low volumes with removable battery motor

drum pump COMBIFLUX **FP 314 PP/S-32/25** in polypropylene with stainless steel shaft, sealless, brushless DC **battery motor FBM-B 3100**, includes 18 V Li-Ion battery, charger 220-240 V, 50-60 Hz, PVC hose DN 19, 2 m long with hand nozzle PP AdBlue® * version with small outlet Ø 19 mm

	immersion length	part no.	
for drum emptying	1.000 mm	10-31449ZV2	●



* AdBlue® is a registered trademark of: Verband der Automobilindustrie e. V. (VDA)

Pump kits about series F 400

Pump kit "acids and alkalis"

drum pump in polypropylene with hastelloy C shaft, **commutator motor FEM 4070**, 230-240 V, 50-60 Hz, 500 watt with speed control and no-volt-release, PVC hose DN 19, 2 m long with hand nozzle in PP and compression gland PP (G 2" male)

- drum pump **F 430 PP-40/33** with mechanical seal, seal material FKM

	immersion length	part no.	
for drum emptying	1.000 mm	10-40740010	●
for IBC emptying	1.200 mm	10-40740012	●

- drum pump **F 424 PP-41/36** sealless

	immersion length	part no.	
for drum emptying	1.000 mm	10-40744010	●
for IBC emptying	1.200 mm	10-40744012	●

Pump kit "concentrated acids"

drum pump **F 430 PVDF-40/33** in polyvinylidene fluoride with hastelloy C shaft, mechanical seal, seal material FKM, **commutator motor F 458**, 230-240 V, 50-60 Hz, 460 watt with no-volt-release, chemical hose DN 19, 2 m long with hand nozzle in PVDF, compression gland PP (G 2" male)

	immersion length	part no.	
for drum emptying	1.000 mm	10-45860010	●
for IBC emptying	1.200 mm	10-45860012	●

Pump kit "FES 800" for the transfer of cleaning and disinfecting agents

drum pump **F 424 PP-41/36** in polypropylene with hastelloy C shaft, sealless, with FLUX fume gland (FES), **commutator motor FEM 4070**, 230-240 V, 50-60 Hz, 500 watt, with speed control and no-volt-release, PVC hose DN 19, 2 m long and hand nozzle PP

	immersion length	part no.	
for 60 litre containers	800 mm	10-40744208	●

Pump kit "AdBlue®" * for IBC emptying

container pump **F 424 PP/S-41/35 Z** in polypropylene with stainless steel shaft, sealless, **commutator motor FEM 4070**, 230-240 V, 50-60 Hz, 500 watt, with speed control and no-volt-release

- with PVC hose DN 19, 3 m long, with hand nozzle in PP and compression gland PP (G 2" male)

	immersion length	part no.	
for IBC emptying	1.200 mm	10-40744112	●

- with special hose DN 16, 6 m long, with **hand nozzle with auto-stop function** in AL and compression gland PP (G 2" male)

	immersion length	part no.	
for IBC emptying	1.200 mm	10-40741ZV6	●

* AdBlue® is a registered trademark of: Verband der Automobilindustrie e. V. (VDA)



Pump kits

Pump kit “petroleum products”

drum pump **F 430 AL-41/38** in aluminium with stainless steel shaft, mechanical seal, seal material NBR, petroleum hose DN 25, 2 m long, hand nozzle AL and compression gland PP (G 2" male)

- with **commutator motor FEM 4070**, 230-240 V, 50-60 Hz, 500 watt with speed control and no-volt-release

	immersion length	part no.	
for drum emptying	1.000 mm	10-40710010	●
for IBC emptying	1.200 mm	10-40710012	●

- with **commutator motor F 457**, 230-240 V, 50-60 Hz, 800 watt, with no-volt-release

	immersion length	part no.	
for drum emptying	1.000 mm	10-45710010	●
for IBC emptying	1.200 mm	10-45710012	●



Pump kit “highly flammable liquids”

drum pump **FP 424 Ex S-43/38** for applications in Zone 0, Ex-marking II 1/2 G Ex h IIB T4...T3 Ga/Gb, in stainless steel with stainless steel shaft, sealless, 2 m earth wire, universal hose DN 21, 2 m long, electrically conductive with brass hose fittings and hand nozzle in brass, compression gland PP electrically conductive (G 2" male)

- with **commutator motor F 460 Ex**, 230-240 V, 50-60 Hz, 460 watt, with no-volt-release for applications in Zone 0, Ex-marking II 2 G Ex db eb IIC T6 or T5 Gb

	immersion length	part no.	
for drum emptying	1.000 mm	10-46024010	●
for IBC emptying	1.200 mm	10-46024012	●

- with **commutator motor F 460 Ex EL**, 230-240 V, 50-60 Hz, 460 Watt, with no-volt-release, with electronic speed adjustment for use in zone 1, Ex marking II 2 G Ex db eb IIC T6 resp. T5 Gb

	immersion length	part no.	
for drum emptying	1.000 mm	10-46024110	●
for IBC emptying	1.200 mm	10-46024112	●

- with **compressed-air motor F 416 Ex**, 470 watt at 6 bar for applications in Zone 0, Ex-marking II 2G Ex h IIC T6 Gb

	immersion length	part no.	
for drum emptying	1.000 mm	10-41624010	●
for IBC emptying	1.200 mm	10-41624012	●



Pump kit “99,98 % drum emptying”

drum pump **FP 425 Ex S-41/34** for applications in Zone 0, Ex-marking III 1/2 G Ex h IIB T4...T3 Ga/Gb, in stainless steel with stainless steel shaft, mechanical seal (FKM), 2 m earth wire, universal hose DN 21, 2 m long electrically conductive with stainless steel hose fittings and hand nozzle, compression gland PP electrically conductive (G 2" male)

- with **commutator motor F 460 Ex**, 230-240 V, 50-60 Hz, 460 watt with no-volt-release for applications in Zone 1, Ex-marking II 2 G Ex db eb IIC T6 or T5 Gb

	immersion length	part no.	
for drum emptying	1.000 mm	10-46025010	●
for IBC emptying	1.200 mm	10-46025012	●



Pump kit “universal applications”

drum pump **F 430 S-41/38** in stainless steel, for applications in Zone 0, Ex-marking II 1/2G Ex h IIB T4 Ga/Gb with stainless steel shaft, mechanical seal (FKM), 2 m earth wire, universal hose DN 21, 2 m long electrically conductive with stainless steel hose fittings and hand nozzle, compression gland PP electrically conductive (G 2" male)

- with **commutator motor F 460 Ex**, 230-240 V, 50-60 Hz, 460 watt with no-volt-release for applications in Zone 1, Ex-marking II 2 G Ex db eb IIC T6 or T5 Gb

	immersion length	part no.	
for drum emptying	1.000 mm	10-46020010	●
for IBC emptying	1.200 mm	10-46020012	●

- with **compressed-air motor F 416 Ex**, 470 watt at 6 bar for applications in Zone 1, Ex-marking II 2G Ex h IIC T6 Gb

	immersion length	part no.	
for drum emptying	1.000 mm	10-41620010	●
for IBC emptying	1.200 mm	10-41620012	●

Pump kit MINIFLUX

drum pump **MINIFLUX S-41/38-136** in stainless steel with stainless steel shaft, mechanical seal FKM, PVC hose DN 19, 2 m long, hand nozzle PP

- with **commutator motor FEM 4070**, 230-240 V, 50-60 Hz, 500 watt

	part no.	
for IBC emptying	10-40729000	●

Pump kit “fire brigade”

drum pump **F 430 PP-40/33** in polypropylene with hastelloy C shaft, mechanical seal, seal material FKM, PVC hose DN 19, 2 m, with hand nozzle PP

- with **commutator motor F 458**, 24 V DC, 410 watt

	immersion length	part no.	
for drum emptying	1.000 mm	10-45840610	●

Pump kit “fire brigade” for industrial applications up to 25.000 mPas

Progressive cavity pump VISCOPOWER **F 570 1200 FKM** FKM SP TS R52 PTFE G16 F 570 planetary gear, with ratio 1:16 torsion shaft, in stainless steel, with open mechanical seal, seal made of FKM, outer Ø 53 mm, connection Clamp 2“, food and chemical hose DN 32, 2,5 m long, discharge spout in stainless steel

- with **commutator motor F 458-1**, 230-240 V, 50-60 Hz, 700 Watt, IP 55, with no-volt release

	immersion length	part no.	
or drum emptying	1.200 mm	10-45890004	●



Pump kits

Pump kit for food and pharmaceuticals

FP 427 S-43/38 FOOD drum pump in stainless for contact with food in accordance with (EC) 1935/2004 and FDA CFR 21 sealless, materials in contact with medium in stainless steel, PTFE, FKM, outer tube diameter 43 mm, 1 1/2" clamp connection, food hose DN 25, 2 m long, with hose fittings and hand nozzle in stainless steel, compression gland PP (G 2)

- with **commutator motor F 458**, 230-240 V, 50-60 Hz, 460 Watt, IP 55 with no-volt release, with special sealing for extreme usage conditions

	immersion length	part no..	
for drum emptying	1.000 mm	10-45827610	●
for IBC emptying	1.200 mm	10-45827612	●



Pump kit for food and pharmaceuticals in Ex version

FP 430 Ex FOOD S-41/38 drum pump in stainless for contact with food in accordance with (EC) 1935/2004 and FDA CFR 21

Ex marking II 1/2G Ex h IIB T4 Ga/Gb, for use in zone 0

With mechanical seal in oxide ceramics, PTFE/carbon, seals in FKM, shaft and rotor in stainless steel 316 Ti, outer diameter 41 mm, 1 1/2" clamp connection food hose DN 19, 2 m long, with hose fittings and hand nozzle in stainless steel, compression gland PP (G 2)

- with **commutator motor F 460 Ex**, 230-240 V, 50-60 Hz, 460 Watt, with no-volt release
Ex marking II 2 G Ex db eb IIC T6 Gb

	immersion length	part no..	
for drum emptying	1.000 mm	10-46020510	●
for IBC emptying	1.200 mm	10-46020512	●



Pump kit for food and pharmaceuticals up to 25.000 mPas

Progressive cavity pump VISCOPOWER

F 570 FOOD FKMc FKM SP TS R33 PTFE G16

for contact with food in accordance with (EC) 1935/2004 and FDA CFR 21 F 570 planetary gear, ratio 1:16, torsion shaft, in stainless steel, with closed mechanical seal, seals made of FKM, outer Ø 53 mm, connection Clamp 2", stator material PTFE, food hose DN 25, 2.5 m long, with hose fittings and discharge spout in stainless steel, compression gland PP (G 2)

- with **commutator motor F 458-1**, 230-240 V, 50-60 Hz, 700 Watt, IP 55, with no-volt release, connection cable 5 m

	immersion length	part no..	
for drum emptying	1.000 mm	10-45890002	●
for IBC emptying	1.200 mm	10-45890003	●



Pump kit for industrial applications up to 30.000 mPas

Progressive cavity pump VISCOPOWER

F 570 FKM0 FKM SP TS R33 PTFE G16

F 570 planetary gear, ratio 1:16, torsion shaft, in stainless steel, with closed mechanical seal, seals made of FKM, outer Ø 53 mm, connection Clamp 2" with adapter on G 1 1/2" external thread, stator material PTFE, food hose DN 32, 2.5 m long, with hose fittings and discharge spout in stainless steel, compression gland PP (G 2)

- with **commutator motor F 457**, 230-240 V, 50-60 Hz, 800 Watt, with splash water protection IP 24, with no-volt release, 5 m connection cable

	immersion length	part no..	
for drum emptying	1.000 mm	10-45790002	●
for IBC emptying	1.200 mm	10-45790003	●



JUNIORFLUX/COMBIFLUX (series 300)

for low volumes



JUNIORFLUX (series 300)

with integral motor

F 300

JUNIORFLUX F 310 with mechanical seal, in polypropylene with hastelloy C shaft

seal in FKM, G 1" male discharge connection with **commutator motor F 310**, 230-240 V, 50-60 Hz, 230 watt, splash-proof to IP 24. Without hose connections. PP-25 suitable for narrow openings < 32 mm.

- **F 310 PP-25/19**

immersion length	part no.	
500 mm	10-31041005	●
700 mm	10-31041007	●
1.000 mm	10-31041010	●

- **F 310 PP-32/25**

immersion length	part no.	
500 mm	10-31042005	●
700 mm	10-31042007	●
1.000 mm	10-31042010	●

JUNIORFLUX F 314 sealless, with hastelloy C shaft

G 1" male discharge connection with **commutator motor F 310**, 230-240 V, 50-60 Hz, 230 watt, splash-proof to IP 24. Without hose connections. PP-25 and PVDF-25 models suitable for narrow openings < 32 mm. Not recommended for small solids, abrasive or crystallising liquids.

- **F 314 PP-25/19** in polypropylene

immersion length	part no.	
500 mm	10-31441005	●
700 mm	10-31441007	●
1.000 mm	10-31441010	●

- **F 314 PP-32/25** in polypropylene

immersion length	part no.	
500 mm	10-31442005	●
700 mm	10-31442007	●
1.000 mm	10-31442010	●

- **F 314 PVDF-25/19** in polyvinylidene fluoride

immersion length	part no.	
500 mm	10-31461005	●
700 mm	10-31461007	●
1.000 mm	10-31461010	●

JUNIORFLUX F 314, sealless, in stainless steel, with stainless steel shaft

G ¾" male discharge connection with **commutator motor F 310**, 230-240 V, 50-60 Hz, 230 watt, splash-proof to IP 24, without hose connections. Not recommended for abrasive or crystallising liquids.

- **F 314 S-28/25**

immersion length	part no.	
500 mm	10-31421005	●
700 mm	10-31421007	●
1.000 mm	10-31421010	●



Hose connection see page 14

COMBIFLUX (series 300)

with separate motor



Drum pump FP 314, sealless, combined with commutator motor (FEM 3070) or battery motor (FBM-B 3100). Not recommended for small solids, abrasive or crystallising liquids.

COMBIFLUX FP 314, sealless pump

- **FP 314 PP-25/19** in polypropylene with **hastelloy C shaft**, G 1" male discharge connection. Without hose connections

immersion length	part no.	
500 mm	10-31445905	●
700 mm	10-31445907	●
1.000 mm	10-31445910	●

- **FP 314 PP-32/25** in polypropylene with **hastelloy C shaft**, G 1" male discharge connection. Without hose connections

immersion length	part no.	
500 mm	10-31446905	●
700 mm	10-31446907	●
1.000 mm	10-31446910	●
1.200 mm	10-31446912	●

- **FP 314 PVDF-25/19** in polyvinylidene fluoride with **hastelloy C shaft**, G 1" male discharge connection. Without hose connections

immersion length	part no.	
500 mm	10-31465905	●
700 mm	10-31465907	●
1.000 mm	10-31465910	●

- **FP 314 S-28/25** in stainless steel with **stainless steel shaft**, G ¾" male discharge connection. Without hose connections

immersion length	part no.	
500 mm	10-31426905	●
700 mm	10-31426907	●
1.000 mm	10-31426910	●
1.200 mm	10-31426912	●



F 300

Drive motors suitable for COMBIFLUX FP 314

- **commutator motor FEM 3070**, 230 watt, splash-proof to IP 24 with 5 m cable and plug

	part no.	
230-240 V, 50-60 Hz,	10-30701000	●
120 V, 60 Hz	10-30701002	●
110 V, 50-60 Hz	10-30701003	●
100 V, 50-60 Hz	10-30701004	●



- **brushless DC battery motor FBM-B 3100**, with electronic temperature control, splash-proof to IP 44, includes Li-Ion 18 V, 2.5 Ah battery

	part no.	
with charger 220-240 V, 50-60 Hz	10-30101000	●
with charger 100-120 V, 50-60 Hz	10-30101003	●
without charger	10-30101001	●



Accessories for battery motor FBM-B 3100

- **battery without charger**, type Li-ion, 18 V, 2,5 Ah

	part no.	
B25-3100	10-30102002	●



- **charger without battery**, BCH-3100, 50-60 Hz

	part no.	
220-240 V	10-30102003	●
100-120 V	10-30102004	●



Hose connection see page 14

Accessories

JUNIORFLUX/COMBIFLUX (series 300)

F 300

Hose connections consisting of hose connector and union nut for JUNIORFLUX F 310/F 314 and COMBIFLUX FP 314

material	nominal Ø	part no.	
PP	DN 13/DN 19	10-95904135	●
PVDF	DN 13	10-95904071	●
PVDF	DN 19	10-95904072	●
S	DN 13	10-95904133	●
S	DN 19	10-95904147	●



PVC hoses

	operating pressure max.	part no.	
DN 13 outer Ø 20 mm (with fabric lining)	10 bar	10-00110008	●
DN 19 outer Ø 27 mm (with steel wire-helix)	5 bar	10-00110040	●

Stepless 1-ear hose clips for PVC hoses

	part no.	
DN 13	10-95913237	●
DN 19	10-95913241	●



Hand nozzles

material	nominal Ø	outlet-Ø	part no.	
PP	DN 13	11 mm	10-00113034	●
PP	DN 19	11 mm	10-00113039	●
PP	DN 19	22 mm	10-00112500	●
PVDF	DN 19	22 mm	10-00112501	●
S	DN 19	28 mm	10-00112541	●
S	G 3/4	28 mm	10-00112555	●



Hose kit for JUNIORFLUX/COMBIFLUX

PVC hose 1,5 m long with hand nozzle in PP (spout Ø 11 mm), hose connection and hose clip

connection	part no.	
DN 13	10-00110825	●
DN 19	10-00110846	●



Discharge spout for JUNIORFLUX/COMBIFLUX

Material: PP

connection	part no.	
union nut G 1	10-95907008	●



Flow meter FMT 120 PP with interlocked wheel impeller in the measuring chamber

in conjunction with our JUNIORFLUX/COMBIFLUX pumps. Construction in PP with fibreglass, not ex-proof, outlet connection G 1" male, O-ring PTFE

inlet connection female	part no.	
G 1	10-A0500101	●
G 1 ¼	10-A0500102	●



Drum adaptor for safety attachment of the JUNIORFLUX/COMBIFLUX pumps in canisters or plastic drums

	material	pump Ø	part no.	
canister bunghole 40 - 70 mm	PVC	32 mm	10-00114081	●
canister bunghole 40 - 70 mm	PP/PVC	28 mm	10-00114079	●
canister bunghole 40 - 70 mm	PP/PVC	25 mm	10-00114080	●
canister bunghole 40 - 70 mm	PVDF/PVC	28 mm	10-00114082	●
canister bunghole 40 - 70 mm	PVDF/PVC	25 mm	10-00114083	●



Drum and container pumps

series 400



Drive motors

for drum and container pumps, series 400
and progressive cavity pumps VISCOPOWER F 570



commutator motor
FEM 4070



commutator motor
F 457
F 457 EL



commutator motor
F 458
F 458 EL
F 458-1





commutator motor
F 460 Ex
F 460-1 Ex
F 460 Ex EL



brushless motor
FBM 4000 Ex

Type	capacity (watt)	speed control	protection class	cable	plug	with no-volt-release	without no-volt-release
						part no.	part no.

motors with 230-240 volt, 50-60 Hz

FEM 4070	500	yes	IP 24	5 m	CEE 7 / 17	10-40701000*	●	10-40701001*	●
				5 m	-	10-40701004*	●	10-40701005*	●
F 457	800	no	IP 24	5 m	CEE 7 / 17	10-45701068	●	10-45701065	●
				5 m	-	10-45701086	●	10-45701085	●
F 457 EL	800	yes	IP 24	5 m	CEE 7 / 17	10-45701066	●	10-45701088	●
				5 m	-	10-45701087	●	-	
F 458	460	no	IP 55	5 m	CEE 7 / 7	10-45800034	●	10-45800031	●
F 458 EL	460	yes	IP 55	5 m	CEE 7 / 7	10-45800047	●	-	
F 458-1	700	no	IP 55	5 m	CEE 7 / 7	10-45801026	●	10-45801025	●
 F 460 Ex	460	no	IP 55	5 m	CEE 7 / 7	10-46000047	●	10-46000044	●
				5 m	-	10-46000059	●	10-46000058	●
				5 m	Ex-CEE type CEAG	12-46030017	●	12-46030035	●
				5 m	Ex-CEE type Stahl	12-46030006	●	12-46030044	●
 F 460 Ex EL	460	yes	IP 55	5 m	CEE 7 / 7	10-46000067	●	-	
				5 m	-	10-46000069	●	-	
				5 m	Ex-CEE type CEAG	12-46030052	●	-	
				5 m	Ex-CEE type Stahl	12-46030042	●	-	
 F 460-1 Ex	700	no	IP 55	5 m	CEE 7 / 7	10-46001028	●	10-46001027	●
				5 m	-	10-46001038	●	10-46001037	●
				5 m	Ex-CEE type CEAG	12-46030032	●	12-46030014	●
				5 m	Ex-CEE type Stahl	12-46030033	●	12-46030043	●

motors with 230-240 Volt, 50-60 Hz for ambient temperature to 60 °C in Ex area

 F 460 Ex HT	420-470	no	IP 55	5 m	-	10-46000064	●	10-46000063	●
F 460 Ex HT	420-470	no	IP 55	-	Ex-CEE type CEAG	12-46030062	●	12-46030045	●

motors with 230 Volt, 50-60 Hz

 FBM 4000 Ex	600	yes	IP 55	5 m	CEE 7 / 7	10-40001003	●	-	
				5 m	-	12-40000010	●	-	
				5 m	Ex-CEE type CEAG	12-40000007	●	-	
				5 m	Ex-CEE type Stahl	12-40000008	●	-	

Ex-marking: II 2 G Ex db eb IIC T6 bzw. T5 Gb

* Motors without anti-rotation device



commutator motor
FEM 4070



commutator motor
F 457
F 457 EL



commutator motor
F 458
F 458 EL
F 458-1



commutator motor
F 460 Ex
F 460 Ex UL

Type	capacity (watt)	speed control	protection class	cable	plug	with no-volt-release	without no-volt-release
						part no.	part no.

motors with 100 Volt, 50-60 Hz

FEM 4070	450	yes	IP 24	5 m	JIS C8303	10-40701020*	●	10-40701021*	●
F 460 Ex	460	no	IP 55	5 m	-	-	-	12-46030024	●

motors with 110 Volt, 50 Hz

FEM 4070	500	yes	IP 24	5 m	CEE 7/17	10-40701016*	●	10-40701017*	●
				5 m	-	10-40701018*	●	10-40701019*	●
F 457	800	no	IP 24	5 m	CEE 7/17	10-45701072	●	10-45701073	●
				5 m	-	10-45701078	●	10-45701077	●
F 457 EL	800	yes	IP 24	5 m	CEE 7/17	10-45701074	●	-	-
				5 m	-	10-45701080	●	-	-
F 458	460	no	IP 55	5 m	-	12-45830005	●	-	-
F 458-1	700	no	IP 55	5 m	CEE 7/7	12-45830006	●	-	-
				5 m	-	12-45830007	●	-	-
F 460 Ex	460	no	IP 55	5 m	-	12-46030009	●	-	-
F 460-1 Ex	700	no	IP 55	5 m	CEE 7/7	12-46030011	●	-	-
				5 m	-	12-46030012	●	-	-

motors with 110 Volt, 50-60 Hz

F 458	460	no	IP 55	5 m	-	-	-	12-45830002	●
F 458-1	700	no	IP 55	5 m	-	-	-	10-45801033	●
F 460 Ex	460	no	IP 55	5 m	-	-	-	12-46030019	●
F 460-1 Ex	700	no	IP 55	5 m	-	-	-	12-46030020	●

motors with 120 Volt, 60 Hz

FEM 4070	500	yes	COF ENC 2	5 m	NEMA 1-15P	10-40701012*	●	10-40701013*	●
			IP 24	5 m	NEMA 1-15P	10-40701014*	●	10-40701015*	●
F 457	800	no	IP 24	5 m	NEMA 1-15P	10-45701067	●	10-45701063	●
F 457 EL	800	yes	IP 24	5 m	NEMA 1-15P	10-45701064	●	-	-
F 458	460	no	COF CSA ENC 3 TP	5 m	NEMA 5-15P	-	-	10-45800044	●
F 458-1	700	no	COF CSA ENC 3 TP	5 m	NEMA 5-15P	-	-	10-45801034	●
F 460-1 Ex UL	700	no	-	5 m	-	-	-	10-46001040	●
F 460 Ex UL	460	no	-	5 m	-	-	-	10-46000062	●

motors with 24 Volt, DC

F 458	410	no	IP 55	5 m	-	-	-	10-45800032	●
F 460 Ex	410	no	IP 55	5 m	-	-	-	10-46000045	●

motors with 12 Volt, DC

F 458	230	no	IP 55	5 m	-	-	-	10-45800033	●
F 460 Ex	230	no	IP 55	5 m	-	-	-	10-46000046	●

Ex-marking: II 2 G Ex db eb IIC T6 bzw. T5 Gb

* Motors without anti-rotation device

Accessories for motors

for drum and container pumps, series 400

Accessories for motors F 457, F 458, F 460 Ex and FBM 4000 Ex

- **CEE plug**, for applications in Zone 1, 3-poles, 200-250 V

System	part no.
CEAG, Ex-marking: II 2 G Ex db eb IIC/IIB+H2 T6	10-93701030 ●
Stahl, Ex-marking II 2G Ex eb IIC T6...T5 Gb	10-93701047 ●

- **CEE socket**, for applications in Zone 1, 3-poles, 200-250 V

System	part no.
CEAG, Ex-marking: II 2 G Ex eb IIC T6	10-93750041 ●
Stahl, Ex-marking II 2G Ex eb IIC T6...T5 Gb	10-93750067 ●

- **earth wire with crocodile clip**

	cable cross-section	length	clamp	part no.
spiral cable (yellow)	3 mm ²	4 m	stainless steel	10-93190023 ●
cable (green/yellow)	4 mm ²	2 m	steel	10-93190015 ●

- **carrying handle**, Rilsan-coated

	part no.
F 457	10-00110533 ●
F 458, F 458-1	10-00110500 ●

- **carrying handle**, cpl. with earth wire

	part no.
F 460 Ex, FBM 4000 Ex	10-00110596 ●

- **inertia hoist**, rope length 2 m

	part no.
carrying force 9 – 14 kg	10-00121000 ●
carrying force 16 – 21 kg	10-00121002 ●

Three-phase gear motors for drum and container pumps

- **F 414**, 230/400 V, 50 Hz, jet-proof to IP 55, **with motor protection switch**

	part no.
0,55 kW energy efficiency class IE2	10-41401145 ●
0,75 kW energy efficiency class IE3	10-41401147 ●
1,1 kW energy efficiency class IE3	10-41401149 ●

- **F 414**, 230/400 V, 50 Hz, jet-proof to IP 55, **with cable terminal box**

	part no.
0,55 kW energy efficiency class IE2	10-41401144 ●
0,75 kW energy efficiency class IE3	10-41401146 ●
1,1 kW energy efficiency class IE3	10-41401148 ●

Accessories for three-phase gear motors F 414

- **carrying handle**

	part no.
stainless steel	10-00110582 ●

- **power supply cable**

	part no.
pre-assembled with sleeve and Cekon plug, 5 m long	10-93408020 ●
pre-assembled with sleeve without plug, 5 m long	10-93408025 ●
per meter	10-93408901 ●
electrical mounting commutator motor	10-Z0500MKS ●
electrical mounting three-phase motor	10-Z0500DKS ●

- **cekon plug**

	part no.
5-poles	10-93701014 ●
5-poles with commutator	10-93701035 ●

- **motor protection switch**, jet-proof to IP 55, with 2 cable entry ports

	part no.
1,30 – 2,00 A	10-93606168 ●
1,80 – 3,00 A	10-93606169 ●
2,80 – 4,60 A	10-93606170 ●



image similar



image similar



image similar



Compressed-air motors F 416 Ex for drum and container pumps

470 watt at 6 bar, 14 liter/sec. air consumption, with anti-rotation device, for applications in Zone 1, Ex-marking II 2G Ex h IIC T6 Gb.

Require dry, clean, lubricated air.

• F 416 Ex	part no.	
with operating valve (adjustable and lockable)	10-41600131	●
• F 416-1 Ex	part no.	
no valve, for automatic control	10-41600132	●
• F 416-2 Ex	part no.	
with ball valve, to regulate speed	10-41600133	●

Accessories for compressed-air motors F 416 Ex

• filter-regulator-lubricator unit G 1/4" female connection	part no.				
for non hazardous areas	10-00110130	●			
explosion-proof	10-00110140	●			
• compressed-air hose	part no.				
DN 10, electrically conductive, EPDM, black, outer Ø 17.5 mm	10-00110913	●			
DN 10, PVC, outer Ø 17 mm	10-00110071	●			
• hose coupling with hose connection in brass	part no.				
DN 10	10-95913066	●			
• coupling in brass	part no.				
DN 7,2 - G 1/4" male	10-95913210	●			
• threaded nipple in brass for hose coupling	part no.				
DN 10, G 1/4" male	10-95913065	●			
• hose nozzle (brass)	part no.				
DN 10, G 1/4" male	10-95905022	●			
• plug-in sleeve in brass	part no.				
DN 10	10-95913209	●			
• 1-ear hose clip	part no.				
Ø 14,8; clamping range 8-18 mm	10-95913237	●			
• earth wire with crocodile clip					
	cable cross-section	length	clamp	part no.	
spiral cable (yellow)	3 mm ²	4 m	stainless steel	10-93190023	●
cable (green/yellow)	4 mm ²	2 m	steel	10-93190015	●
• fine filter sound absorber with oil separator	part no.				
complete with mounting bracket	10-94715005	●			
• exhaust air hose kit for compressed-air motors F 416	part no.				
PVC hose DN13, 5 m long					
connections G 1/2 - G 1/2 A (both male threads) for compressed-air motors F 416 with additional fine filter silencer with oil separator	10-00110886	●			



Drum and container pumps, series 400

Drum pump FP 424, sealless, not recommended for small solids, abrasive or crystallising liquids. 50 mm diameter options for high flow applications. G 1¼" male discharge connection, with FLUX-Clip, without hose connection.

in stainless steel (S)

for applications in Zone 0, Ex-marking II 1/2 G Ex h IIB T4...T3 Ga/Gb, with zone separation

- **FP 424 Ex S-43/38, FKM seal**, stainless steel shaft
- **FP 424 Ex S-43/38, FEP seal**, stainless steel shaft

immersion length	part no.	
700 mm	10-42422007	●
1.000 mm	10-42422010	●
1.200 mm	10-42422012	●

immersion length	part no.	
700 mm	10-42429307	●
1.000 mm	10-42429310	●
1.200 mm	10-42429312	●

- **FP 424 Ex S-43/38, EPDM seal**, stainless steel shaft

immersion length	part no.	
1.000 mm	10-42428010	●
1.200 mm	10-42428012	●

- **FP 424 Ex S-43/37 Z, FKM seal**, stainless steel shaft **(for increased pumping head)**

immersion length	part no.	
700 mm	10-42422107	●
1.000 mm	10-42422110	●
1.200 mm	10-42422112	●

- **FP 424 Ex S-43/37 Z, FEP seal**, stainless steel shaft **(for increased pumping head)**

immersion length	part no.	
700 mm	10-42429407	●
1.000 mm	10-42429410	●
1.200 mm	10-42429412	●

- **FP 424 Ex S-50/45 Z, FKM seal**, stainless steel shaft **(for increased pumping head)**

immersion length	part no.	
700 mm	10-42422207	●
1.000 mm	10-42422210	●
1.200 mm	10-42422212	●

- **FP 424 Ex S-50/45 Z, FEP seal**, stainless steel shaft **(for increased pumping head)**

immersion length	part no.	
700 mm	10-42429507	●
1.000 mm	10-42429510	●
1.200 mm	10-42429512	●

in stainless steel (S), HT version

for application in Zone 0, for ambient temperature to +60 °C, Ex-marking II 1/2 G Ex h IIB T4...T3 Ga/Gb, with zone separation

- **FP 424 Ex (HT) S-43/38 FKM seal**, stainless steel shaft

immersion length	part no.	
1.000 mm	10-42422310	●
1.200 mm	10-42422312	●

- **FP 424 Ex (HT) S-43/37 Z FKM seal**, stainless steel shaft **(for increased pumping head)**

immersion length	part no.	
1.000 mm	10-42422410	●
1.200 mm	10-42422412	●

- **FP 424 Ex (HT) S-50/45 Z FKM seal**, stainless steel shaft **(for increased pumping head)**

immersion length	part no.	
1.000 mm	10-42422510	●
1.200 mm	10-42422512	●

in polypropylene (PP)

- **F 424 PP-41/36, FKM seal, hastelloy C shaft**

immersion length	part no.	
700 mm	10-42440007	●
1.000 mm	10-42440010	●
1.200 mm	10-42440012	●

- **F 424 PP-41/36, FKM seal, titanium shaft**

immersion length	part no.	
700 mm	10-42440707	●
1.000 mm	10-42440710	●
1.200 mm	10-42440712	●

- **F 424 PP-41/36, EPDM seal, hastelloy C shaft**

immersion length	part no.	
700 mm	10-42448007	●
1.000 mm	10-42448010	●
1.200 mm	10-42448012	●



Other seal materials available on request

* AdBlue® is a registered trademark of: Verband der Automobilindustrie e. V. (VDA)

illustration with hose connection (not included)

in polypropylene (PP)

- **F 424 PP-41/35 Z, FKM seal, hastelloy C shaft (for increased pumping head)**

immersion length	part no.	
700 mm	10-42440107	●
1.000 mm	10-42440110	●
1.200 mm	10-42440112	●

- **F 424 PP-50/38 , FKM seal, hastelloy C shaft**

immersion length	part no.	
700 mm	10-42440207	●
1.000 mm	10-42440210	●
1.200 mm	10-42440212	●

in polyvinylidene fluoride (PVDF)

- **F 424 PVDF-41/36, FKM seal, hastelloy C shaft**

immersion length	part no.	
700 mm	10-42460007	●
1.000 mm	10-42460010	●
1.200 mm	10-42460012	●

- **F 424 PVDF-41/35Z, FKM seal, hastelloy C shaft (for increased pumping head)**

immersion length	part no.	
700 mm	10-42460107	●
1.000 mm	10-42460110	●
1.200 mm	10-42460112	●

- **F 424 PP/S-41/35 Z, FKM seal, stainless steel shaft, AdBlue® version*, free from non-ferrous materials**

immersion length	part no.	
1.000 mm	10-42440510	●
1.200 mm	10-42440512	●

- **F 424 PP-50/43 Z, FKM seal, hastelloy C shaft (for increased pumping head)**

immersion length	part no.	
700 mm	10-42440307	●
1.000 mm	10-42440310	●
1.200 mm	10-42440312	●

- **F 424 PVDF-41/36 FFKM seal, hastelloy C shaft**

immersion length	part no.	
700 mm	10-42469007	●
1.000 mm	10-42469010	●
1.200 mm	10-42469012	●

- **F 424 PVDF-50/38, FKM seal, hastelloy C shaft**

immersion length	part no.	
700 mm	10-42460207	●
1.000 mm	10-42460210	●
1.200 mm	10-42460212	●



F 400

F 424 PVDF

Drum pump F 425 for 99,98 % drum emptying

with mechanical seal, G 1¼" male discharge connection, with FLUX-Clip, without hose connection, stainless steel and hastelloy C version: for applications in Zone 0, Ex-marking stainless steel version: II 1/2 G Ex h IIB T4...T3 Ga/Gb Ex-marking hastelloy C version: II 1/2G Ex h IIB T4 Ga/Gb

- **FP 425 Ex S-41/34 in stainless steel, stainless steel shaft and FKM seal (with zone separation)**

immersion length	part no.	
700 mm	10-42522008	●
1.000 mm	10-42522011	●
1.200 mm	10-42522013	●

- **FP 425 Ex S-41/34 in stainless steel, stainless steel shaft, EPDM seal (with zone separation)**

immersion length	part no.	
1.000 mm	10-42528011	●
1.200 mm	10-42528013	●

- **F 425 PP-50/34 in polypropylene, Hastelloy C shaft, EPDM seal**

immersion length	part no.	
1.200 mm	10-42548051	●
1.500 mm	10-42548053	●

- **F 425 HC-40/34 in hastelloy C, hastelloy C shaft and FFKM seal**

immersion length	part no.	
1.200 mm	10-42530007	●
1.500 mm	10-42530008	●

- **FP 425 Ex S-41/34 in stainless steel, stainless steel shaft and FFKM seal (with zone separation)**

immersion length	part no.	
1.000 mm	10-42529111	●
1.200 mm	10-42529113	●

- **FP 425 Ex S-41/34Z in stainless steel, stainless steel shaft and FKM seal (for increased pumping head) (with zone separation)**

immersion length	part no.	
1.000 mm	10-42522031	●
1.200 mm	10-42522033	●

- **F 425 PP-50/34 in polypropylene, hastelloy C shaft and FKM seal**

immersion length	part no.	
700 mm	10-42540048	●
1.000 mm	10-42540051	●
1.200 mm	10-42540053	●



FP 425 Ex S

F 425 PP

Other seal materials available on request

Additional cost for silicone-free version on request (only for stainless steel pumps available)

illustration with hose connection (not included)

Drum and container pumps, series 400

Drum pump F 426 for mixing and pumping

with mechanical seal, G 1¼" male discharge connection, with FLUX-Clip, without hose connection
stainless steel version: for applications in Zone 0, Ex-marking II 1/2G Ex h IIB T4 Ga/Gb

- **F 426 S-41/38 in stainless steel, stainless steel shaft and FKM seal**

immersion length	part no.	
1.000 mm	10-42620010	●
1.200 mm	10-42620012	●

- **F 426 S-41/38 in stainless steel, stainless steel shaft and FFKM seal**

immersion length	part no.	
1.000 mm	10-42629010	●
1.200 mm	10-42629012	●

- **Accessories for F 426 S**

sealing washer for closing the hose connector during mixing

	part no.	
sealing washer, S 316 Ti	10-92569011	●
union nut, S	10-90790002	●
flat seal, PE	10-92564002	●

- **F 426 PP-50/33 in polypropylene, hastelloy C shaft and FKM seal**

immersion length	part no.	
1.000 mm	10-42640001	●
1.200 mm	10-42640002	●

- **Accessories for F 426 PP**

sealing washer for closing the hose connector during mixing

	part no.	
sealing washer, PP	10-92569000	●
union nut, PP	10-90790024	●
flat seal, PTFE	10-92564003	●



F 426 S



F 426 PP

Drum pump F 427, can be taken apart completely

sealless, easy to strip for sterile applications, stainless steel shaft, with FLUX-Clip, without hose connection

in stainless steel

- **F 427 S3-43/38, G 1¼" male discharge connection**

immersion length	part no.	
700 mm	10-42720307	●
1.000 mm	10-42720310	●
1.200 mm	10-42720312	●

- **hose connection with G 1¼" female union nut**

	part no.	
DN 25	10-95904063	●

- **F 427 S4-43/38, Rd 58 x 1/6 thread connection**

immersion length	part no.	
700 mm	10-42720407	●
1.000 mm	10-42720410	●
1.200 mm	10-42720412	●

- **hose connection with Rd 58 x 1/6 union nut**

	part no.	
DN 25	10-95904115	●



F 427

in stainless steel, FOOD version

- suitable for food contact according to Regulation (EC) 1935/2004 and FDA CFR 21
FP 427 S-43/38 FOOD in stainless steel, 1½" clamp connection (other connections on request)

immersion length	part no.	
700 mm	10-42720607	●
1.000 mm	10-42720610	●
1.200 mm	10-42720612	●

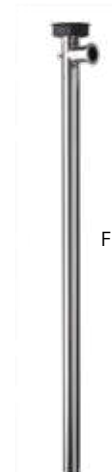

FP 427 FOOD

Accessories for FOOD version see page 39

in stainless steel, 3A version



- **F 427 S3A-43/38 with 1½" clamp connection**

immersion length	part no.	
700 mm	10-42720207	●
1.000 mm	10-42720210	●
1.200 mm	10-42720212	●

- **hose connection with clamp connection 1½"**

	part no.	
DN 19	10-95904138	●

Drive motors see page 16–19, other hose connections see page 27

illustration with hose connection (not included)

Drum pump F 430

with mechanical seal, G 1/4" male discharge connection, with FLUX-Clip, without hose connection.
Suitable for pumping liquids containing small solids or crystallising liquids.

in aluminium, stainless steel shaft and NBR seal

- **F 430 AL-41/38**

immersion length	part no.	
700 mm	10-43010107	●
1.000 mm	10-43010110	●
1.200 mm	10-43010112	●

- **F 430 AL-50/38**

immersion length	part no.	
700 mm	10-43010307	●
1.000 mm	10-43010310	●
1.200 mm	10-43010312	●

- **F 430 AL-41/37 Z (for increased pumping head)**

immersion length	part no.	
700 mm	10-43010407	●
1.000 mm	10-43010410	●
1.200 mm	10-43010412	●



F 430 AL

F 400

in stainless steel, stainless steel shaft

for applications in Zone 0, Ex-marking II 1/2G Ex h IIB T4 Ga/Gb

- **F 430 S-41/38, FKM seal**

immersion length	part no.	
700 mm	10-43020107	●
1.000 mm	10-43020110	●
1.200 mm	10-43020112	●

- **F 430 S-41/38, EPDM seal**

immersion length	part no.	
1.000 mm	10-43028110	●
1.200 mm	10-43028112	●

- **F 430 S-50/38, FKM seal**

immersion length	part no.	
1.000 mm	10-43020310	●

- **F 430 S-41/38, FFKM seal**

immersion length	part no.	
1.000 mm	10-43029110	●
1.200 mm	10-43029112	●

- **F 430 S-41/37 Z, FKM seal (for increased pumping head)**

immersion length	part no.	
700 mm	10-43020407	●
1.000 mm	10-43020410	●
1.200 mm	10-43020412	●

- **F 430 S-50/45 Z, FKM seal (for increased pumping head)**

immersion length	part no.	
700 mm	10-43020207	●
1.000 mm	10-43020210	●
1.200 mm	10-43020212	●



F 430 S

in stainless steel, FOOD version, stainless steel shaft

for applications in Zone 0, Ex-marking II 1/2G Ex h IIB T4 Ga/Gb
suitable for food contact according to Regulation (EC) 1935/2004 and FDA CFR 21



- **FP 430 Ex S-41/38 FOOD** in stainless steel, FKM seal, 1 1/2" clamp connection (other connections on request)

immersion length	part no.	
700 mm	10-43020507	●
1.000 mm	10-43020510	●
1.200 mm	10-43020512	●

- **FP 430 Ex S-41/38 FOOD** in stainless steel, FFKM seal, 1 1/2" clamp connection (other connections on request)

immersion length	part no.	
700 mm	10-43029607	●
1.000 mm	10-43029610	●
1.200 mm	10-43029612	●

in hastelloy C, hastelloy C shaft and FFKM seal

for applications in Zone 0, Ex-marking II 1/2G Ex h IIB T4 Ga/Gb

- **F 430 HC-40/38**

immersion length	part no.	
700 mm	10-43030107	●
1.000 mm	10-43030110	●
1.200 mm	10-43030112	●

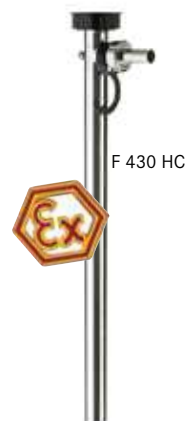

F 430 HC

FFKM O-rings on request

Accessories for FOOD version see page 39

Other seal materials available on request. Additional cost for silicone-free version on request.

Drive motors see page 16–19, hose connections see page 27, mixing tubes see page 38

illustration with hose connection
(not included)

Drum and container pumps, series 400

Drum pump F 430

with mechanical seal, hastelloy C shaft, G 1 1/4" male discharge connection, with FLUX-Clip, without hose connection. Suitable for pumping liquids containing small solids or crystallising liquids. 50 mm diameter options for high flow applications.

in polypropylene (PP)

- **F 430 PP-40/33, FKM seal**

immersion length	part no.	
700 mm	10-43040107	●
1.000 mm	10-43040110	●
1.200 mm	10-43040112	●

- **F 430 PP-40/33, EPDM seal**

immersion length	part no.	
1.000 mm	10-43048110	●
1.200 mm	10-43048112	●

- **F 430 PP-40/33 Z, FKM seal (for increased pumping head)**

immersion length	part no.	
700 mm	10-43040407	●
1.000 mm	10-43040410	●
1.200 mm	10-43040412	●

- **F 430 PP-50/38, FKM seal**

immersion length	part no.	
700 mm	10-43040307	●
1.000 mm	10-43040310	●
1.200 mm	10-43040312	●

- **F 430 PP-50/43 Z, FKM seal (for increased pumping head)**

immersion length	part no.	
700 mm	10-43040207	●
1.000 mm	10-43040210	●
1.200 mm	10-43040212	●



F 430 PP

in polyvinylidene fluoride (PVDF)

- **F 430 PVDF-40/33, FKM seal**

immersion length	part no.	
700 mm	10-43060107	●
1.000 mm	10-43060110	●
1.200 mm	10-43060112	●

- **F 430 PVDF-40/33, FFKM seal**

immersion length	part no.	
1.000 mm	10-43069110	●
1.200 mm	10-43069112	●

- **F 430 PVDF-40/33 Z, FKM seal (for increased pumping head)**

immersion length	part no.	
700 mm	10-43060407	●
1.000 mm	10-43060410	●
1.200 mm	10-43060412	●

- **F 430 PVDF-50/43 Z, FKM seal (for increased pumping head)**

immersion length	part no.	
700 mm	10-43060207	●
1.000 mm	10-43060210	●
1.200 mm	10-43060212	●

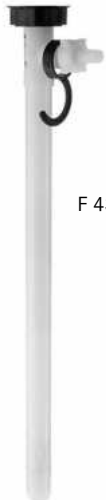

F 430 PVDF

- **F 430 PVDF-50/38, FKM seal**

immersion length	part no.	
700 mm	10-43060307	●
1.000 mm	10-43060310	●
1.200 mm	10-43060312	●

Container pump F 430 in polypropylene with hastelloy C shaft

with mechanical seal, seal material FKM, G 1 1/4" male discharge connection, with FLUX-Clip, without hose connection

- **F 430 PP-100/50**

immersion length	part no.	
1.000 mm	10-43040510	●
1.200 mm	10-43040512	●
1.500 mm	10-43040515	●

- **screw top**

to secure the pump in the container in connection with a compression gland or a fume gland (part numbers see page 36)

nominal Ø	part no.	
DN 150	10-00114063	●
DN 225	10-00114064	●



F 430 PP-100/50



Other seal material on request

Drive motors see page 16–19, hose connections see page 27, mixing tubes see page 38

illustration with hose connection (not included)

Centrifugal pumps for horizontal and vertical installation (dry installation – outside of drum/container)

- **F 430 S-41/38 TR**, stainless steel, with stainless steel shaft, Ex-marking: II 2 G c IIB TX, without hose connection

connection	seal	part no.	
inlet: G 2" male parallel outlet: G 1 1/4" male	FKM	10-43020002	●
inlet: clamp 2" outlet: clamp 1 1/2"	FEP/FFKM	10-43029012	●



- **F 430 PP-40/33 TR** in polypropylene with hastelloy C shaft

connection	seal	part no.	
inlet: G 2" male outlet: G 1 1/4" male	FKM	10-43040002	●

- **hose connections** complete for suction side for F 430 TR

	nominal Ø	part no.	
in stainless steel, with nickel-plated brass G 2" female union nut	DN 32	10-95904059	●
in polypropylene, with PVC G 2" female union nut	DN 32	10-95904010	●
	DN 38	10-95904011	●



- **MINIFLUX IBC pump**, in stainless steel, with stainless steel shaft, Ex-marking: II 2G c IIB TX

connection	seal	part no.	
inlet: union nut S 60 x 6, PP discharge connection: G 1 1/4" male	FKM	10-43020003	●
	FFKM	10-43029003	●
inlet: union nut S 60 x 6, PP discharge connection: Clamp 1 1/2	FKM	10-43020004	●
	FFKM	10-43029005	●
both sides: Clamp 1 1/2	FKM	10-43020005	●
	FFKM	10-43029005	●



- Accessories for **MINIFLUX**

	part no.	
fixation MINIFLUX, wire cable in stainless steel, length 3 m, hook in brass, nickel-plated	10-00110430	●
union nut Rd 60x6, in stainless steel, connection drum pump/IBC	10-90790083	●
union nut Rd 65x1/6, in stainless steel, connection drum pump/motor	10-90790011	●
O-ring FFKM, FDA	10-92575063	●
connecting piece S to FMC 100 / FMO 104 / FMO 110	10-43021043	●



Drum and container pumps, series 400

Container pumps for horizontal use (dry installation) in FOOD version

suitable for food contact in accordance with EC 1935/2004 and FDA CFR 21



- **MINIFLUX Sanitary** with FOOD approval acc. to EC 1935/2004 and FDA CFR 21

connection	seal	part no.	
inlet side: G 2A outlet side: G 1¼ A	FKM	10-43020008	●
inlet side: Clamp 2" outlet side: Clamp 1½"	EPDM	10-43028003	●



Set pump incl. adapter S60x6 for connection to IBC

connection	seal	part no.	
inlet side: G 2A outlet side: G 1¼ A	FKM	10-43020012	●
inlet side: Clamp 2" outlet side: Clamp 1½"	EPDM	10-43028004	●

- **MINIFLUX Sanitary** with FDA approval acc. to FDA CFR 21

connection	seal	part no.	
inlet side: G 2A outlet side: G 1¼ A	FKM	10-43020006	●
inlet side: Clamp 2" outlet side: Clamp 1½"	EPDM	10-43028001	●

Set incl. adapter S60x6 for connection to IBC

connection	seal	part no.	
inlet side: G 2A outlet side: G 1¼ A	FKM	10-43020007	●
inlet side: Clamp 2" outlet side: Clamp 1½"	EPDM	10-43028002	●

- Accessories for **MINIFLUX Sanitary**

	seal	part no.	
adapter S 60x6 - Clamp 2"	FKM	10-95913439	●
adapter S 60x6 - Clamp 2"	EPDM	10-95913440	●
fixation MINIFLUX, wire cable in stainless steel, length 3 m, hook in brass, nickel-plated		10-00110430	●



Drive motors see page 16–19, hose connections see page 27

illustration with hose connection
(not included)

Accessories

for drum and container pumps, series 400



Hose connections

- **stainless steel**, with nickel-plated brass G 1 1/4" female union nut

	part no.	
DN 19	10-95904061	●
DN 25	10-95904041	●
DN 32	10-95904042	●

- **stainless steel**, with stainless steel G 1 1/4" female union nut

	part no.	
DN 19	10-95904062	●
DN 25	10-95904063	●
DN 32	10-95904064	●

- **polypropylene**, with G 1 1/4" female union nut

	part no.	
DN 13	10-95904081	●
DN 19	10-95904053	●
DN 25	10-95904052	●
DN 32	10-95904054	●

- **aluminium**, with nickel-plated brass G 1 1/4" female union nut

	part no.	
DN 19	10-95904050	●
DN 25	10-95904039	●
DN 32	10-95904040	●

- **hastelloy C**, with stainless steel G 1 1/4" female union nut

	part no.	
DN 25	10-95904043	●

- **polyvinylidene fluoride**, with G 1 1/4" female union nut

	part no.	
DN 13	10-95904082	●
DN 19	10-95904101	●
DN 25	10-95904102	●
DN 32	10-95904103	●



F 400

Hose couplings and safety binding

quick hose couplings

consisting of 3 components: female part (hose side), male part and drum pump connector (please order all components at the same time)

- **polypropylene**, with FKM seal

	part no.	
connector: G 1" male - G 1 1/4" female	10-95906179	●
male part: G 1" female	10-95913213	●
female part with DN 25 hose connection	10-95913220	●

- **bronze**, with FKM seal

	part no.	
connector: G 1" male - G 1 1/4" female	10-95906019	●
male part: G 1" female	10-95913211	●
female part with DN 25 hose connection	10-95913219	●

- **stainless steel**, with FKM seal

	part no.	
connector: G 1" male - G 1 1/4" female	10-95906144	●
male part: G 1" female	10-95913215	●
female part with DN 25 hose connection	10-95913221	●

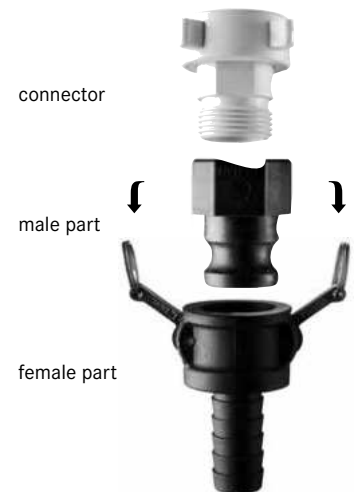

bracket clamp

pressed aluminium jaws for female part (bronze or stainless steel) of quick hose couplings

	for hoses	part no.	
jaws, aluminium	DN 25	10-95913218	●
jaws, stainless steel	DN 38	10-95913365	●
hose connector, S for clamp connection 1 1/2"	DN 38	10-95905174	●



Accessories

for drum and container pumps, series 400

Swaged hose fittings for the connection of pump and hose – recommended for use with lined hoses

(consisting of hose connection ① and bracket clamp or ferrule type with union nut ②)

- with hose connection brass (for use in hazardous areas)

seal	bracket clamp	nominal Ø	version	outer Ø hose	part no.
PUR	-	DN 13 - G ½" female	HE	22 mm	10-95913130 ●
PUR	-	DN 19 - G 1" female	HE	27 mm	10-95913116 ●
-	-	DN 19 - G 1" male	HE	27 mm	10-95913118 ●
PUR	-	DN 19 - G 1¼" female	HE	27 mm	10-95913192 ●
PUR	AL nickel-plated	DN 19 - G 1" female	SL	30 - 33 mm	10-95913157 ●
PUR	AL nickel-plated	DN 19 - G 1¼" female	SL	30 - 33 mm	10-95913180 ●
PUR	AL nickel-plated	DN 21 - G 1¼" female	SL	30 - 33 mm	10-95913230 ●
PUR	-	DN 25 - G 1" female	HE	34 mm	10-95913097 ●
-	-	DN 25 - G 1" male	HE	34 mm	10-95913099 ●
PUR	-	DN 25 - G 1¼" female	HE	34 mm	10-95913098 ●
PUR	AL nickel-plated	DN 25 - G 1" female	SF	36 - 38 mm	10-95913158 ●
PUR	AL nickel-plated	DN 25 - G 1" male	SF	36 - 38 mm	10-95913159 ●
PUR	AL nickel-plated	DN 25 - G 1¼" female	SF	36 - 38 mm	10-95913140 ●
-	AL nickel-plated	DN 25 - G 1¼" male	SF	36 - 38 mm	10-95913188 ●
PUR	AL nickel-plated	DN 32 - G 1¼" female	SF	43 - 45 mm	10-95913014 ●
PUR	AL nickel-plated	DN 32 - G 1½" female	SF	43 - 45 mm	10-95913015 ●
PUR	AL nickel-plated	DN 38 - G 1½" female	SF	50 - 52 mm	10-95913143 ●
PUR	brass	G 1¼" female - G 1" male	reducer		10-95906019 ●
PUR	brass	G 1½" female - G 1¼" male	reducer		10-95906002 ●

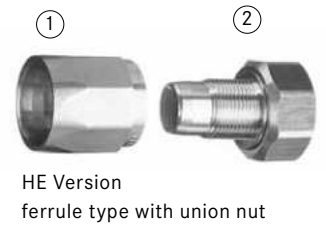

- with hose connection stainless steel (for use in hazardous areas)

seal	bracket clamp	nominal Ø	version	outer Ø hose	part no.
PTFE	AL nickel-plated	DN 13 - G ½" female	SL	22 - 24 mm	10-95913178 ●
PTFE	AL nickel-plated	DN 19 - G 1" female	SL	30 - 33 mm	10-95913160 ●
PTFE	AL nickel-plated	DN 19 - G 1¼" female	SL	30 - 33 mm	10-95913181 ●
PTFE	AL nickel-plated	DN 21 - G 1" female	SL	30 - 33 mm	10-95913233 ●
PTFE	AL nickel-plated	DN 21 - G 1¼" female	SL	30 - 33 mm	10-95913231 ●
PTFE	AL nickel-plated	DN 25 - G 1" female	SF	36 - 38 mm	10-95913161 ●
-	AL nickel-plated	DN 25 - G 1" male	SF	36 - 38 mm	10-95913162 ●
PTFE	AL nickel-plated	DN 25 - G 1¼" female	SF	36 - 38 mm	10-95913144 ●
PTFE	AL nickel-plated	DN 32 - G 1¼" female	SF	43 - 45 mm	10-95913145 ●
PTFE	AL nickel-plated	DN 32 - G 1½" female	SF	43 - 45 mm	10-95913146 ●
PTFE	AL nickel-plated	DN 38 - G 1½" female	SF	50 - 52 mm	10-95913147 ●
PTFE	S	G 1½" female - G 1¼" male	reducer		10-95906005 ●

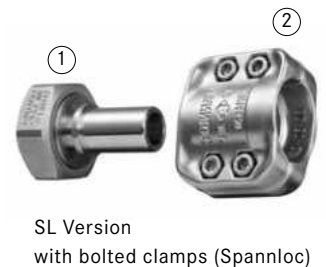

- with hose connection stainless steel, PFA coated (for use in hazardous areas)

bracket clamp	nominal Ø	version	outer Ø hose	part no.
AL nickel-plated	DN 25 - G 1¼" female	SF	36 - 38 mm	10-95913234 ●
AL nickel-plated	DN 25 - G 1" female	SL	36 - 39 mm	10-95913386 ●
AL nickel-plated	DN 25 - G 1" male	SL	36 - 39 mm	10-95913387 ●

- with hose connection polypropylene

seal	bracket clamp	nominal Ø	version	outer Ø hose	part no.
PE	S	DN 13 - G 1" female	SL	22 - 24 mm	10-95913317 ●
PE	S	DN 13 - G 1¼" female	SL	22 - 24 mm	10-95913321 ●
PE	S	DN 19 - G 1" female	SL	30 - 33 mm	10-95913319 ●
PE	S	DN 19 - G 1¼" female	SL	30 - 33 mm	10-95913323 ●
PE	S	DN 21 - G 1¼" female	SL	30 - 33 mm	10-95913325 ●
PE	S	DN 25 - G 1¼" female	SL	36 - 39 mm	10-95913327 ●



- with hose connection polyvinylidene fluoride

seal	bracket clamp	nominal Ø	version	outer Ø hose	part no.
PTFE	S	DN 13 - G 1" female	SL	22 - 24 mm	10-95913318 ●
PTFE	S	DN 19 - G 1" female	SL	30 - 33 mm	10-95913320 ●
PTFE	S	DN 19 - G 1¼" female	SL	30 - 33 mm	10-95913324 ●
PTFE	S	DN 21 - G 1¼" female	SL	30 - 33 mm	10-95913326 ●
PTFE	S	DN 25 - G 1¼" female	SL	36 - 39 mm	10-95913328 ●



Swaged hose fittings for the connection of hose and FLUX hand nozzle

- for hand nozzle PP/FKM part no. 10-001 12 556 with connection Ø 28 mm

hose connection	seal	bracket clamp	nominal Ø	version	outer Ø hose	part no.
PP	FKM	AL nickel-plated	DN 25	SF	36 – 38 mm	10-95913309 ●
PP	FKM	S	DN 19	SL	30 – 33 mm	10-95913330 ●
PP	FKM	S	DN 21	SL	30 – 33 mm	10-95913335 ●
PP	FKM	S	DN 25	SL	36 – 38 mm	10-95913340 ●

- for hand nozzle PP/EPDM part no. 10-001 12 557 with connection Ø 28 mm

hose connection	seal	bracket clamp	nominal Ø	version	outer Ø hose	part no.
PP	EPDM	AL nickel-plated	DN 25	SF	36 – 38 mm	10-95913310 ●
PP	EPDM	S	DN 19	SL	30 – 33 mm	10-95913331 ●
PP	EPDM	S	DN 21	SL	30 – 33 mm	10-95913336 ●
PP	FKM	S	DN 25	SL	36 – 39 mm	10-95913341 ●

- for hand nozzle PVDF/FKM part no. 10-001 12 558 with connection Ø 28 mm

hose connection	seal	bracket clamp	nominal Ø	version	outer Ø hose	part no.
PVDF	FKM	S	DN 13	SL	22 – 24 mm	10-95913329 ●
PVDF	FKM	S	DN 19	SL	30 – 33 mm	10-95913332 ●
PVDF	FKM	S	DN 21	SL	30 – 33 mm	10-95913337 ●
PVDF	FKM	S	DN 25	SL	36 – 39 mm	10-95913342 ●

- for hand nozzle PVDF/EPDM part no. 10-001 12 559 with connection Ø 28 mm

hose connection	seal	bracket clamp	nominal Ø	version	outer Ø hose	part no.
PVDF	EPDM	S	DN 19	SL	30 – 33 mm	10-95913333 ●
PVDF	EPDM	S	DN 25	SL	36 – 39 mm	10-95913343 ●

- for hand nozzle PVDF/FFKM part no. 10-001 12 560 with connection Ø 28 mm

hose connection	seal	bracket clamp	nominal Ø	version	outer Ø hose	part no.
PVDF	FFKM	S	DN 19	SL	30 – 33 mm	10-95913334 ●
PVDF	FFKM	S	DN 21	SL	30 – 33 mm	10-95913339 ●
PVDF	FFKM	S	DN 25	SL	36 – 39 mm	10-95913344 ●



hand nozzle PP
(see page 33)

F 400



hand nozzle PVDF
(see page 33)

Bracket clamp with corrosion protection

in stainless steel ECTFE coated with screws and nuts in HC for hose connection PP or PVDF

version	part no.
DN 25	10-95913347 ●



Swaged hose fittings for the connection of hose and hand nozzle

- for hand nozzle MS part no. 10-001 12 340 with connection Ø 32 mm

hose connection	seal	bracket clamp	nominal Ø	version	outer Ø hose	part no.
brass	FEP	-	DN 19	HE	27 mm	10-95913134 ●
brass	FEP	AL nickel-plated	DN 19	SL	31 mm	10-95913191 ●
brass	FEP	AL nickel-plated	DN 21	SL	31 mm	10-95913229 ●
brass	FEP	-	DN 25	HE	34 mm	10-95913137 ●
brass	FEP	AL nickel-plated	DN 25	SF	37 mm	10-95913152 ●

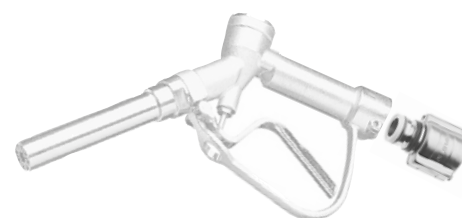

hand nozzle MS
(see page 34)

HE = version ferrule type with union nut

SF = version with pinned safety clamps (Spannfix)

SL = version with bolted clamps (Spannloc)

Accessories

for drum and container pumps, series 400

Swaged hose fittings for the connection of hose and hand nozzle

- for hand nozzle **S** part no. 10-001 12 549 with connection Ø 28 mm

hose connector	seal	bracket clamp	nominal Ø	version	outer Ø hose	part no.	
S	FEP	AL nickel-plated	DN 19	SL	31 mm	10-95913258	●
S	FEP	AL nickel-plated	DN 21	SL	31 mm	10-95913259	●
S	FEP	AL nickel-plated	DN 25	SF	37 mm	10-95913260	●

- for hand nozzle **S** part no. 10-001 12 550 with connection Ø 28 mm and FLUX discharge unit with spring valve FAEplus S part no. 10-001 12 576

hose connector	seal	bracket clamp	nominal Ø	version	outer Ø hose	part no.	
S	FEP	AL nickel-plated	DN 19	SL	31 mm	10-95913276	●
S	FEP	AL nickel-plated	DN 21	SL	31 mm	10-95913277	●
S	FEP	AL nickel-plated	DN 25	SF	37 mm	10-95913278	●



hand nozzle S
(see page 34)

Bonding work

of the chosen hose fittings and hose

bonding work on both sides	part no.	
including testing for electrical conductivity	10-00000100	●
without testing for electrical conductivity (with PP/PVDF hose connector)	10-00000102	●
bonding work on one side, without testing for electrical conductivity	part no.	
swaged hose fittings with MS/S hose connector	10-00000103	●
swaged hose fittings with PP/PVDF hose connector	10-00000104	●

Hose kits with G 1¼" female drum pump connectors

and connection to **brass hand nozzle** part no. 10-001 12 340 with connection Ø 32 mm, electrically conductive with swaged hose fitting in aluminium nickel-plated

- petroleum hose kit**

	length	part no.	
DN 19	2 m long	10-00110091	●
	3 m long	10-00110092	●
DN 25	2 m long	10-00110081	●
	3 m long	10-00110082	●

- universal hose kit**

	length	part no.	
DN 21	2 m long	10-00110839	●
	3 m long	10-00110840	●

- hose kit for food and chemistry**

	length	part no.	
DN 19	2 m long	10-00110089	●
	3 m long	10-00110090	●
DN 25	2 m long	10-00110811	●
	3 m long	10-00110812	●



hand nozzle MS
(see page 34)

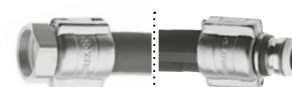

hose kit

Hose kits with G 1¼" female drum pump connectors

and connection to **stainless steel hand nozzle** part no. 10-001 12 549 with connection Ø 28 mm, electrically conductive with swaged hose fitting in aluminium nickel-plated

- universal hose kit**

	length	part no.	
DN 21	2 m long	10-00110870	●
	3 m long	10-00110871	●

- hose kit for food and chemistry**

	length	part no.	
DN 19	2 m long	10-00110873	●
	3 m long	10-00110874	●
DN 25	2 m long	10-00110868	●
	3 m long	10-00110869	●



hand nozzle S
(see page 34)

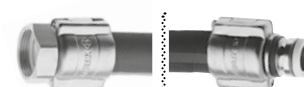

hose kit

Hose lines with hand nozzle with G 1 1/4" female connection to drum pump

- with **hand nozzle PP** (part no. 10-001 12 500 with FKM seal, 10-001 12 506 with EPDM seal), PVC- hose DN 19, 2 m, hose connection PP

seal	part no.
FKM	10-00110813 ●
EPDM	10-00110847 ●

- with **hand nozzle AL** (part no. 10-001 12 172), petroleum hose DN 25, 2 m, hose connector aluminum, union nut brass

seal	part no.
NBR	10-00110815 ●

- with **hand nozzle MS** (part no. 10-001 12 340), universal hose DN 21, 2 m, hose connector brass, bracket clamp AL nickel-plated, electrically conductive integrated

seal	part no.
PTFE	10-00110845 ●

Hose lines with hand nozzle FOOD with 1 1/2" Clamp connection

- with **hand nozzle S** (part no. 10-001 12 568), food hose DN 25, 2 m, hose connector S

seal	part no.
FKM	10-00110898 ●

- with **hand nozzle PVDF** (part no. 10-001 12 558), hose for food and chemistry DN 19, 2 m, hose connector PVDF, bracket clamp AL nickel-plated

seal	part no.
FKM	10-00110814 ●

- with **hand nozzle S** (part no 10-001 12 549), universal hose DN 21, 2 m, hose connector S, bracket clamp AL nickel-plated, electrically conductive integrated

seal	part no.
PTFE/FEP	10-00110872 ●



- with **hand nozzle S** (part no. 10-001 12 568), hose for food and chemistry DN 19, 2 m, hose connector S, electrically conductive integrated

seal	part no.
FKM	10-00110899 ●

Hoses without inliner

for use with hose connections or swaged hose fittings

- PVC hose** with fabric lining also suitable for food contact according to Regulation (EC) 1935/2004

	operating pressure max.	part no.
DN 13 outer Ø 20 mm	10 bar	10-00110008 ●

- PVC hose with steel wire-helix** also suitable for food contact according to Regulation (EC) 1935/2004

	operating pressure max.	part no.
DN 19 outer Ø 27 mm	5 bar	10-00110040 ●
DN 25 outer Ø 33 mm	5 bar	10-00110041 ●
DN 32 outer Ø 41 mm	4,5 bar	10-00110042 ●
DN 38 outer Ø 47 mm	4 bar	10-00110043 ●
DN 50 outer Ø 60 mm	3 bar	10-00110044 ●

- petroleum hose** electrically conductive Ω to EN 12115:2011 material inside: NBR black

	operating pressure max.	part no.
DN 13 outer Ø 21 mm	10 bar	10-00110076 ●
DN 19 outer Ø 27 mm	10 bar	10-00110065 ●
DN 25 outer Ø 34 mm	10 bar	10-00110002 ●

electrically conductive Ω/T to EN 12115:2011 material inside: NBR black

	operating pressure max.	part no.
DN 32 outer Ø 44 mm	25 bar	10-00110003 ●
DN 38 outer Ø 51 mm	25 bar	10-00110004 ●



Accessories

for drum and container pumps, series 400

- **special food-grade hose**

suitable for food contact according to Regulation (EC) 1935/2004 and FDA CFR 21 material inside: NBR white

	operating pressure max.	part no.	
DN 25 outer Ø 37 mm	16 bar	10-00110118	●
DN 32 outer Ø 44 mm	16 bar	10-00110923	●
DN 38 outer Ø 51 mm	16 bar	10-00110119	●



Hoses with inliner

for use with swaged hose fittings

- **universal hose**, electrically conductive Ω to EN 12115:2011 material inside: fluoropolymer THV seamless

	operating pressure max.	part no.	
DN 21 outer Ø 31 mm	16 bar	10-00110838	●



- **hose for food and chemistry**, electrically conductive Ω /T to EN 12115:2011 suitable for food contact according to Regulation (EC) 1935/2004 and FDA CFR 21 material inside: ultra-high molecular PE transparent

	operating pressure max.	part no.	
DN 13 outer Ø 22 mm	16 bar	10-00110085	●
DN 19 outer Ø 31 mm	16 bar	10-00110037	●
DN 25 outer Ø 37 mm	16 bar	10-00110030	●
DN 32 outer Ø 43 mm	16 bar	10-00110036	●
DN 38 outer Ø 51 mm	16 bar	10-00110086	●



- **PTFE hose**, electrically conductive Ω /T-type acc. to EN 12115 suitable for food contact according to Regulation (EC) 1935/2004 and 10/2001 and FDA material inside: PTFE

	operating pressure max.	part no.	
DN 19 outer Ø 31 mm	16 bar	10-00110892	●
DN 25 outer Ø 37 mm	16 bar	10-00110893	●



Stepless 1-ear hose clip

in stainless steel 316 Ti for use with hose connection

- for **PVC hose**

	outer Ø	part no.	
DN 13	18 mm	10-95913237	●
DN 19	27 mm	10-95913241	●
DN 25	34 mm	10-95913243	●
DN 32	41 mm	10-95913248	●
DN 38	47 mm	10-95913251	●
DN 50	60 mm	10-95913255	●



- for **petroleum hose**

	outer Ø	part no.	
DN 13	21 mm	10-95913239	●
DN 19	27 mm	10-95913371	●
DN 25	34 mm	10-95913243	●
DN 32	43 mm	10-95913249	●
DN 38	51 mm	10-95913252	●



- for **special food-grade hose**

	outer Ø	part no.	
DN 25	37 mm	10-95913246	●
DN 38	51 mm	10-95913254	●



Forceps to attach the 1-ear hose clip

	part no.	
	10-96140811	●



Non explosion-proof hand nozzles

Hand nozzles with hose connection for use with hoses without inliner (see page 31)

- **hand nozzle PP** (polypropylene) **with small outlet**

nominal Ø	seal	outlet Ø	part no.	
DN 13	FKM	6 mm	10-00113001	●
DN 13	FKM	11 mm	10-00113034	●
DN 19	FKM	11 mm	10-00113039	●
DN 19	FKM	20 mm	10-00113000	●
DN 25	FKM	20 mm	10-00113035	●

- **hand nozzle PP** (polypropylene) **with swivel inlet**, outlet Ø 25 mm

nominal Ø	seal	part no.	
DN 19	FKM	10-00112500	●
DN 25	FKM	10-00112504	●
DN 19	EPDM	10-00112506	●
DN 25	EPDM	10-00112510	●

- **hand nozzle PP** (polypropylene) **AdBlue®** version* with swivel inlet, outlet Ø 19 mm

nominal Ø	seal	part no.	
DN 19	FKM	10-00112518	●

- **hand nozzle PVDF** (polyvinylidene fluoride) **with swivel inlet**, outlet Ø 25 mm

nominal Ø	seal	part no.	
DN 13	FKM	10-00112515	●
DN 19	FKM	10-00112501	●
DN 25	FKM	10-00112505	●
DN 19	EPDM	10-00112507	●
DN 25	EPDM	10-00112511	●
DN 19	FFKM	10-00112512	●
DN 25	FFKM	10-00112514	●

- **hand nozzle AL** (aluminium) **with swivel inlet**, outlet Ø 25 mm

nominal Ø	seal	part no.	
DN 19	NBR	10-00112397	●
DN 25	NBR	10-00112172	●

Hand nozzles without hose connection for use with hoses with inliner (see page 32)

swaged hose fittings see page 29

- **hand nozzle PP** (polypropylene) **with swivel inlet**, outlet Ø 25 mm

nominal Ø	seal	part no.	
28 mm	FKM	10-00112556	●
28 mm	EPDM	10-00112557	●

- **hand nozzle PVDF** (polyvinylidene fluoride) **with swivel inlet**, outlet Ø 25 mm

nominal Ø	seal	part no.	
28 mm	FKM	10-00112558	●
28 mm	FFKM	10-00112560	●

- **hand nozzle AL** (aluminium) with swivel inlet, outlet Ø 25 mm

nominal Ø	seal	part no.	
G 1" female	NBR	10-00112171	●



F 400

* AdBlue® is a registered trademark of: Verband der Automobilindustrie e. V. (VDA)

Accessories

for drum and container pumps, series 400

Explosion-proof hand nozzles

for applications in Zone 1

Hand nozzles with hose connection for use with hoses without inliner (see page 31)

- **hand nozzle S** (stainless steel), outlet Ø 28 mm

nominal Ø	seal	part no.	
DN 19	PTFE/FEP	10-00112541	●
DN 25	PTFE/FEP	10-00112542	●
G ¾" female	PTFE/FEP	10-00112555	●

- **hand nozzle S** (stainless steel) fluorine-free version, outlet Ø 28 mm

nominal Ø	seal	part no.	
G 1" male	EPDM	10-00112545	●

- **hand nozzle MS** (brass nickel-plated), outlet Ø 25 mm

nominal Ø	seal	part no.	
DN 19	PTFE	10-00112396	●
DN 25	PTFE	10-00112337	●
DN 32	PTFE	10-00112338	●



Hand nozzles without hose connection for use with hoses with inliner (see page 32)

for direct mounting onto FLUX hose kits page 30
or swaged hose fittings page 28-29

- **hand nozzle S** (stainless steel), outlet Ø 28 mm

nominal Ø	seal	part no.	
Ø 28	PTFE/FEP	10-00112549	●
G 1" male	PTFE/FEP	10-00112543	●
G 1 ¼" male	PTFE/FEP	10-00112544	●

- **hand nozzle MS** (brass nickel-plated), outlet Ø 25 mm

nominal Ø	seal	part no.	
Ø 32	PTFE	10-00112340	●
G 1" male	PTFE	10-00112389	●
G 1" female	PTFE	10-00112339	●



Hand nozzles with auto-stop function

- **hand nozzle AL 20** (aluminium), outlet Ø 24 mm

nominal Ø	version	seal	part no.	
G 1" male	with rigid inlet	PTFE	10-00112109	●
G 1" male	with swivel inlet	NBR	10-00112347	●

- **hand nozzle AL 20 R** (aluminium unleaded), outlet Ø 21 mm

nominal Ø	version	seal	part no.	
G 1" male	with swivel inlet	NBR	10-00112097	●

- **hand nozzle AL** (aluminium) for „AdBlue®“, outlet Ø 19 mm

nominal Ø	version	seal	part no.	
G 1" male	AdBlue® *	NBR	10-00112417	●

- **suitable for hand nozzle AL** for „AdBlue®“ *

	part no.	
magnetic adapter	10-00112453	●



* AdBlue® is a registered trademark of: Verband der Automobilindustrie e. V. (VDA)

Accessories for hand nozzles

- **protection cover** for hand nozzle S

	part no.	
in stainless steel	11-00000638	●

- **longer outlet tube** for mounting on hand nozzle

material	part no.	
PP, 220 mm long, Ø 20 mm	10-00112228	●
PVDF, 220 mm long, Ø 20 mm	10-00112241	●
S, 100 mm long, Ø 10 mm	10-00112661	●
S, 135 mm long, Ø 28 mm	10-00112657	●
S, 220 mm long, Ø 20 mm	10-00112285	●

- **stop valve in polypropylene** for hand nozzles (is inserted in outlet) or for outlet tube PP Ø 20

	seal	spring	part no.	
for outlet tube PP Ø 20	FKM	S	10-95914019	●
	FFKM	HC	10-95914026	●
for hand nozzle S with outlet Ø 28 (not permitted for use in hazardous areas)	FKM	S	10-95914064	●
	FFKM	HC	10-95914066	●



FLUX discharge units with spring valve (FAEplus) for media up to 300 cP without solids content

wired version with start/stop button, with drip valve, without control cable (page 72), without mounting the control cable

- FLUX discharge units with spring valve **with hose connection**, outlet Ø 32 mm

	material	seal	part no.	
FAEplus PP	PP	FKM	10-00112571	●
FAEplus PP	PP	EPDM	10-00112572	●
FAEplus PVDF	PVDF	FKM	10-00112573	●
FAEplus PVDF	PVDF	FFKM	10-00112574	●
FAEplus PVDF	PVDF	EPDM	10-00112575	●
FAEplus S	S	FKM	10-00112576	●
FAEplus S	S	FFKM	10-00112577	●
FAEplus S	S	EPDM	10-00112578	●



- **accessory for discharge unit**

spiral tape for fixation of the cable on the hose

	part no.	
Ø 20 - 100 mm	10-00110072	●

5-core control cable for the connection of the discharge unit with the switching amplifier

	part no.	
5 m long	10-93408038	●
10 m long	10-93408040	●
15 m long	10-93408041	●

drip valve IG M 29x1,5, seal EPDM

material	part no.	
PP	10-95914077	●
PVDF	10-95914078	●
S	10-95914079	●

FLUX flow meters see from page 61

Hose fittings and hoses see from page 28

Accessories

for drum and container pumps, series 400

FES fume glands and accessories control emission of dangerous vapours from drums and IBC

Consisting of valve part and threaded ring

(please order both parts for a complete unit)

- **valve part PP** (polypropylene), with FKM O-ring, with G 1/4" female connection for hose nozzle

pump Ø	part no.	
25 mm	10-00114309	●
32 mm	10-00114313	●
40 mm	10-00114181	●
41 mm	10-00114182	●
50 mm	10-00114243	●



valve part with ball valve

- **threaded ring PP** (polypropylene) with FKM flat seal

pump Ø	thread connection	part no.	
25/32/40/41 mm	G 2" B male (G2" / BSP 2")	10-00114218	●
25/32/40/41 mm	CCS 57 x 4 male thread	10-00114224	●
25/32/40/41 mm	CCS 60 x 6 female thread (S60x6 / DIN 61)	10-00114228	●
25/32/40/41 mm	CCS 70 x 6 female thread (S70x6 / DIN 71)	10-00114226	●
25/32/40/41 mm	CCS 70 x 6 male thread (S70x6 / DIN 71)	10-00114232	●
25/32/40/41 mm	BCS 70 x 6 (with O-ring) male thread (2" Mauser / TriSure S70x6)	10-00114236	●
50 mm	G 2" B male (G2" / BSP 2")	10-00114238	●
50 mm	CCS 70 x 6 male thread (S70x6 / DIN 71)	10-00114267	●
40/41 mm	CCS 64 x 5 male thread	10-00114230	●



- **valve part S** (stainless steel), with FEP O-ring with G 3/8" female connection - for use in ATEX areas

pump Ø	part no.	
28 mm (FKM O-ring)	10-00114319	●
41 mm	10-00114192	●
41 mm with gas compensation connector DN 10	10-00114194	●
50 mm	10-00114253	●
50 mm with gas compensation connector DN 10	10-00114245	●



valve part with 3/8" BSPPF gas compensation connector

- **threaded ring S** (stainless steel), with PE flat seal - for use in ATEX areas

pump Ø	nominal Ø	part no.	
28/41 mm	G 2" male (G2" / BSP 2")	10-00114325	●
28/41 mm	CCS 57 x 4 male thread	10-00114329	●
50 mm	G 2" male (G2" / BSP 2")	10-00114331	●

- **threaded ring MS** (brass), with PE flat seal - for use in ATEX areas

pump Ø	nominal Ø	part no.	
41 mm	G 2" male (G2" / BSP 2")	10-00114327	●



Accessories for additional use of a gas compensation connector

- **hose nozzle** (PP) for valve part PP, DN 10 - G 1/4" male

part no.	
10-95913128	●



- **PE corrugated hose** for gas compensation

part no.	
10-00110061	●

- **EPDM compressed air hose** for gas compensation

part no.	
10-00110913	●



- **fume cone** (polypropylene, electrically conductive) for hand nozzle with outlet DN 10

part no.	
10-00114285	●
10-00114296	●



Compression gland – secure pump into drum or IBC

material	pump Ø	connection	part no.	
polyethylene	41 mm	57 x 4 male thread	10-00114067	●
polyethylene	41 mm	70 x 6 male thread	10-00114065	●
polyethylene	50 mm	70 x 6 male thread	10-00114066	●
polypropylene	40/41 mm	R 2 male, electrically conductive	10-00114054	●
polypropylene	50 mm	R 2 male, electrically conductive	10-00114062	●
steel/zinc-plated	40 mm	M 64 x 4 / G 2" male thread	10-00114061	●
steel/zinc-plated	41 mm	M 64 x 4 / G 2" male thread	10-00114000	●
steel/zinc-plated	50 mm	G 2" male thread	10-00114003	●
steel/zinc-plated	50 mm	M 64 x 4 male thread	10-00114002	●



Screw top for IBC – use with G2" male compression gland

connection	part no.	
DN 150	10-00114063	●
DN 225	10-00114064	●



Pump inlet suction strainers – for liquids containing solid particles

material	pump Ø	outer Ø	part no.	
polypropylene	40/41 mm	53 mm	10-00110200	●
polypropylene	50 mm	60 mm	10-00110205	●
polyvinylidene fluoride	40/41 mm	53 mm	10-00110245	●
polyvinylidene fluoride	50 mm	60 mm	10-00110267	●
stainless steel	41 mm	53 mm	10-00110209	●
stainless steel	43 mm (for FP 424 S-43/38 and -43/37Z)	53 mm	10-00110294	●
stainless steel	50 mm	59 mm	10-00110212	●



Discharge spout

with union nut G 1¼" female – to suit drum pump outlet

material	nominal Ø	part no.	
stainless steel (S)	DN 25	10-95907007	●
polypropylene (PP)	DN 19	10-95907009	●



Quick action coupling SSK 400

use where quick or frequent disassembly of pump and motor is required

	part no.	
complete	10-00110802	●
threaded ring (motor)	10-00110800	●
clamping element (pump)	10-00110804	●



Tools

	part no.	
jointed hood-wrench for fume glands , 60-90 mm, for capstan nuts DIN 1816, stud Ø 5mm	10-96142500	●
key for coupling star	10-96140889	●

Accessories

for drum and container pumps, series 400

Attachment clamps

- **wall brackets** in stainless steel 1.4301, with screws for fixing

for drum and container pumps	part no.	
	10-00110426	●

- **attachment clamp**, material: steel zinc-plated, polypropylene

for pump Ø	part no.	
40/41 mm	10-00110601	●
50 mm	10-00110603	●

- **container clip**, stainless steel 1.4301, rilsan-coated

for pump Ø	part no.	
40/41 mm	10-00115005	●
50 mm	10-00115006	●



Mixing tubes

for drum pumps instead of the outer tube for dedicated mixing applications in drums or IBCs

- for F 430 AL-41/38

immersion length	part no.	
700 mm	10-43011192	●
1.000 mm	10-43011193	●
1.200 mm	10-43011194	●

- for F 430 S-41/38 (not allowed in hazardous areas)

immersion length	part no.	
700 mm	10-43021192	●
1.000 mm	10-43021193	●
1.200 mm	10-43021194	●

- for F 430 PP-40/33

immersion length	part no.	
700 mm	10-43041192	●
1.000 mm	10-43041193	●
1.200 mm	10-43041194	●



Non-return valves

- stainless steel, seal FKM for mounting onto pump discharge

for pumps	part no.	
FP 424 - F 430 G 1 ¼ - G 1 ¼ A	10-95914024	●
¾" on both sides	10-95914022	●

- stainless steel, seal PTFE

connection	part no.	
G 1 ¼ - G 1 ¼ A	10-95914048	●
G 1" on both sides	10-95914047	●

- polypropylene, FKM seal, for mounting onto pump foot

for pumps	part no.	
F 430 PP-40/33	10-95914029	●
F 430 PP-40/33Z	10-95914030	●

- polyvinylidene fluoride, FKM seal, for mounting onto pump foot

for pumps	part no.	
F 430 PVDF-40/33	10-95914038	●
F 430 PVDF-40/33Z	10-95914039	●



Accessories for drum and container pumps in FOOD version

suitable for food contact according to Regulation (EC) 1935/2004 and FDA CFR 21



- hose connections**

material: stainless steel 316 Ti, pump connection clamp 1½"

nominal Ø	seal	part no.	
DN 19	FKM	10-95904171	●
DN 19	NBR	10-95904172	●
DN 25	FKM	10-95904169	●
DN 25	NBR	10-95904170	●



- swaged hose fittings for the connection of pump and hose**

for use with hose or special hose for food and chemistry, screwed version, stainless steel 316 Ti, connection pump clamp 1½", DN 40

nominal Ø	seal	part no.	
DN 19	FKM	10-95913354	●
DN 19	NBR	10-95913355	●
DN 25	FKM	10-95913356	●
DN 25	NBR	10-95913357	●



F 400

- discharge spout**

material: stainless steel

nominal Ø	seal	part no.	
1 ½" clamp (Ø 28)	FKM	10-95907030	●
1 ½" clamp (Ø 28)	NBR	10-95907033	●

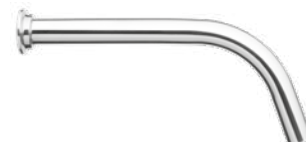

- outlet tube for hand nozzle S**

stainless steel 316 Ti, G ¾ male connection, 100 mm long, Ø 10 mm

seal	part no.	
PTFE, FDA	10-00112658	●

- flap valve**

material: stainless steel, connection pump clamp 1½", DN 40

seal	part no.	
FKM	10-95919010	●
NBR	10-95919012	●



- joint clamp for flap valve DN 40**

material	connection	part no.	
stainless steel	clamp 1 ½"	10-43021019	●



- seals for flap valve DN 40**

material	part no.	
EPDM, FDA/FOOD	10-92569017	●
NBR, FDA/FOOD	10-92569015	●
FKM, FDA/FOOD	10-92569014	●
PTFE, FDA/FOOD	10-92569016	●

- hand nozzle**

for use with FLUX drum pump FP 430 S FOOD (for alcohols) outlet Ø 28 mm

material	nominal Ø	seal	part no.	
stainless steel	clamp 1 ½"	PTFE/FKM	10-00112658	●



Hoses see page 32

Progressive cavity pumps

VISCOPOWER F 570 and F 580



Progressive cavity pumps

VISCOPOWER F 570 with double stage gearbox $i=16$

VISCOPOWER Pumps F 570 - with double stage gearbox $i=16$

open mechanical seal, FKM seal, stator material PTFE, torsion shaft

immersion depth	rotor geometry	part no.	
700 mm	R33	12-57000001	●
700 mm	R52	12-57000004	●
1.000 mm	R17	12-57000007	●
1.000 mm	R33	12-57000002	●
1.000 mm	R52	12-57000005	●
1.200 mm	R17	12-57000008	●
1.200 mm	R33	12-57000003	●
1.200 mm	R52	12-57000006	●



open mechanical seal, NBR seal, stator material NBR white, torsion shaft

immersion depth	rotor geometry	part no.	
1.000 mm	R33	12-57000011	●
1.000 mm	R52	12-57000013	●
1.200 mm	R33	12-57000012	●
1.200 mm	R52	12-57000014	●

open mechanical seal, FKM seal, stator material PTFE ATEX, torsion shaft, with Ex approval, ex-marking II 1/2 G Ex h IIB T4...T3 Ga/Gb



immersion depth	rotor geometry	part no.	
1.000 mm	R33	12-57000021	●
1.200 mm	R33	12-57000022	●

closed mechanical seal, FKM seal, stator material PTFE, torsion shaft, for food contact according to regulation (EC) 1935/2004 and FDA CFR 21



immersion depth	rotor geometry	part no.	
1.000 mm	R33	12-57000015	●
1.000 mm	R52	12-57000017	●
1.200 mm	R33	12-57000016	●
1.200 mm	R52	12-57000018	●

closed mechanical seal, FKM seal, stator material PTFE, torsion shaft, with 3-A approval, for food contact according to regulation (EC) 1935/2004 and FDA CFR 21



immersion depth	rotor geometry	part no.	
1.000 mm	R33	12-57000019	●
1.000 mm	R52	12-57000020	●

outlet adapter see page 47

hose connections see page 47

drive motors for gear version see page 16-17

F 570
 $i=16$

Accessories for motors F 457, F 458, F 460 Ex and FBM 4000 Ex

- **CEE plug**, for applications in Zone 1, 3-poles, 200-250 V

System	part no.	
CEAG, Ex-marking: II 2 G Ex db eb IIC/IIB+H2 T6	10-93701030	●
Stahl, Ex-marking II 2G Ex eb IIC T6...T5 Gb	10-93701047	●



- **CEE socket**, for applications in Zone 1, 3-poles, 200-250 V

System	part no.	
CEAG, Ex-marking: II 2 G Ex eb IIC T6	10-93750041	●
Stahl, Ex-marking II 2G Ex eb IIC T6...T5 Gb	10-93750067	●



- **earth wire with crocodile clip**

	cable cross-section	depth	clamp	part no.	
spiral cable (yellow)	3 mm ²	4 m	stainless steel	10-93190023	●
cable (green/yellow)	4 mm ²	2 m	steel	10-93190015	●



- **carrying handle, Rilsan-coated**

	part no.	
F 457	10-00110533	●
F 458, F 458-1	10-00110500	●



- **carrying handle, cpl. with earth wire**

	part no.	
F 460 Ex, FBM 4000 Ex	10-00110596	●



- **inertia hoist, rope depth 2 m**

	part no.	
carrying force 9 - 14 kg	10-00121000	●
carrying force 16 - 21 kg	10-00121002	●



Drive motors and accessories

Compressed-air motors F 416 Ex for drum and container pumps

470 watt at 6 bar, 14 liter/sec. air consumption, for applications in Zone 1, Ex-marking II 2G Ex h IIC T6 Gb. Require dry, clean, lubricated air.

- **F 416 Ex**

	part no.	
with operating valve (adjustable and lockable)	10-41600131	●

- **F 416-1 Ex**

	part no.	
no valve, for automatic control	10-41600132	●

- **F 416-2 Ex**

	part no.	
with ball valve, to regulate speed	10-41600133	●



Accessories for compressed-air motors F 416 Ex

- **filter-regulator-lubricator unit G 1/4" female connection**

	part no.	
for non hazardous areas	10-00110130	●
explosion-proof	10-00110140	●

- **compressed-air hose**

	part no.	
DN 10, electrically conductive, EPDM, blue, outer Ø 17 mm	10-00110913	●

- **hose coupling with hose connection in brass**

	part no.	
DN 10	10-95913066	●

- **coupling in brass**

	part no.	
DN 7,2 - G 1/4" male	10-95913210	●

- **threaded nipple in brass for hose coupling**

	part no.	
DN 10, G 1/4" male	10-95913065	●

- **hose nozzle (brass)**

	part no.	
DN 10, G 1/4" male	10-95905022	●

- **plug-in sleeve in brass**

	part no.	
DN 10	10-95913209	●

- **1-ear hose clip**

	part no.	
Ø 14,8; clamping range 8-18 mm	10-95913237	●

- **earth wire with crocodile clip**

	cable cross-section	depth	clamp	part no.	
spiral cable (yellow)	3 mm ²	4 m	stainless steel	10-93190023	●
cable (green/yellow)	4 mm ²	2 m	steel	10-93190015	●

- **fine filter sound absorber with oil separator**

	part no.	
complete with mounting bracket	10-94715005	●

- **exhaust air hose kit for compressed-air motors F 416**
PVC hose DN13, 5 m long

	part no.	
connections G 1/2 - G 1/2 A (both male threads) for compressed-air motors F 416 with additional fine filter silencer with oil separator	10-00110886	●



further accessories for drive motors can be found in our detailed FLUX Accessories brochure.

Progressive cavity pumps

VISCOPOWER F 570 with single-stage gear $i=7$



VISCOPOWER pumps F 570 with single-stage gear $i=7$

- open mechanical seal, FKM seal, torsion shaft

immersion depth [mm]	rotor geometry	stator material	part no.
1.000 mm	R33	PTFE	12-57000024 ●
1.000 mm	R52	PTFE	12-57000023 ●



Appropriate motors F 403

- **single phase AC motor**, 230 V, 50 Hz, IP 55, with motor protection switch, 5 m cable and plug

	part no.
F 403/2 , 0,50 kW, 3.000 rpm	10-40301023 ●
F 403/4 , 0,55 kW, 1.500 rpm	10-40301024 ●

- **three-phase motor**, 230/400 V, 50 Hz, IP 55, with motor protection switch, without cable

	part no.
F 403/4 , 0,55 kW, 1.500 rpm	10-40301025 ●
F 403/2 , 0,75 kW, 3.000 rpm	10-40301026 ●

- **three-phase motor**, 230/400 V, 50 Hz, IP 55, with cable terminal box, without cable, ex-marking Ex II 2G Ex eb IIC T3 Gb



	part no.
F 403/4 Ex , 0,55 kW, 1.500 rpm	10-40301030 ¹ ●



image similar

F 570
 $i=7$

Progressive cavity pumps

VISCOPOWER F 580 with motor flange

VISCOPOWER pumps F 580 with motor flange

- **open mechanical seal, FKM seal, stator material PTFE**

immersion depth	rotor geometry	shaft	part no.	
700 mm	R33	cardan	12-58000001	●
700 mm	R52	cardan	12-58000004	●
1.000 mm	R33	torsion	12-58000002	●
1.000 mm	R52	torsion	12-58000005	●
1.200 mm	R33	torsion	12-58000003	●
1.200 mm	R52	torsion	12-58000006	●

- **open mechanical seal, NBR seal, stator material NBR white, torsion shaft**

immersion depth	rotor geometry	part no.	
1.000 mm	R17	12-58000009	●
1.000 mm	R33	12-58000011	●
1.200 mm	R17	12-58000010	●
1.200 mm	R33	12-58000012	●

- **open mechanical seal, FKM seal, stator material PTFE ATEX, torsion shaft, ex-protected, ex-marking II 1/2 G Ex h IIB T4...T3 Ga/Gb**

immersion depth	rotor geometry	part no.	
1.000 mm	R33	12-58000017	●
1.200 mm	R33	12-58000018	●

- **closed mechanical seal, FKM seal, stator material PTFE, torsion shaft, for food contact according to regulation (EC) 1935/2004 and FDA CFR 21**

immersion depth	rotor geometry	part no.	
1.000 mm	R52	12-58000013	●
1.200 mm	R52	12-58000014	●



- **closed mechanical seal, FKM seal, stator material PTFE, torsion shaft, with 3-A approval, for food contact according to regulation (EC) 1935/2004 and FDA CFR 21**

immersion depth	rotor geometry	part no.	
1.000 mm	R33	12-58000015	●
1.000 mm	R52	12-58000016	●



- **adapter flange kit for VISCOPOWER pumps F 580**
anodized aluminum, with coupling half size 24 and 4 screws

suitable for	part no.	
IEC standard motors size 90 design B14	10-00110915	●
IEC standard motors size 100/112 design B14	10-00110920	●

- **sensor cable for VISCOPOWER with pulser**

	part no.	
5 m long, for connection of sensor and evaluation unit FLUXTRONIC®	11-00000192	●



outlet adapter see page 47

hose connections see page 47

drive motors for motor flange version see page 50

Accessories for progressive cavity pump

VISCOPOWER F 570 and F 580



• stators

rotor geometry	material	regulation	part no.	
R17	NBR white	FDA conform, (EC) No. 1935/2004	11-00000031	●
	FKM		11-00000032	●
	PTFE	FDA conform, (EC) No. 1935/2004	11-00000033	●
	PTFE ATEX	FDA conform, (EC) No. 1935/2004	11-00000034	●
R33	NBR white	FDA conform, (EC) No. 1935/2004	11-00000035	●
	FKM		11-00000036	●
	PTFE	FDA conform, (EC) No. 1935/2004	11-00000037	●
	PTFE ATEX	FDA conform, (EC) No. 1935/2004	11-00000038	●
R52	NBR white	FDA conform, (EC) No. 1935/2004	11-00000039	●
	FKM		11-00000040	●
	PTFE	FDA conform, (EC) No. 1935/2004	11-00000041	●
	PTFE ATEX	FDA conform, (EC) No. 1935/2004	11-00000042	●
	EDPM white	FDA conform, (EC) No. 1935/2004	11-000000386	●
R83	NBR white	FDA conform, (EC) No. 1935/2004	11-00000043	●
	FKM		11-00000044	●



• stator housing

	part no.	
with suction protection	11-00000145	●
with clamping socket 2"	11-00000392	●
with inliner suction protection	11-00000147	●
with suction protection 3-A	11-00000146	●
with inliner suction protection 3-A	11-00000148	●



• outlet adapter in stainless steel, FKM seal and hinged clamp

	part no.	
Clamp 2" on G 1/2" AG	11-00000159	●
Clamp 2" on G 1" AG	11-00000160	●
Clamp 2" on G1 1/2" AG	11-00000161	●
Clamp 2" on G1 1/4" AG	11-00000543	●
Clamp 2" on RD 58x1/6" AG	11-00000162	●
Clamp 2" on RD 65x1/6" AG	11-00000163	●
Clamp 2" on G 2" AG	11-00000231	●



• tools

	part no.	
jaws	10-96142504	●
staking tool	11-00000194	●



• hose connections in stainless steel

connection	seal	part no.	
DN 25, G 1 1/2, with union nut	PE	10-95904002	●
DN 32, G 1 1/2, with union nut	PE	10-95904003	●
DN 38, G 1 1/2, with union nut	PE	10-95904004	●
DN 25, Rd 58 x 1/6, with union nut	-	10-95904115	●
DN 32, Rd 58 x 1/6, with union nut	-	10-95904134	●
DN 38, Rd 58 x 1/6, with union nut	-	10-95904130	●
DN 32, Clamp 2", with hinged clamp	FKM	10-95904173	●
DN 38, Clamp 2", with hinged clamp	FKM	10-95904175	●



Accessories for progressive cavity pumps

VISCOPOWER F 570 and F 580

- **attachment clamp**, material: steel zinc-plated, PP

for pump Ø	part no.	
53 mm	11-00000209	●



- **container clip**, stainless steel 1.4301

for pump Ø	part no.	
53 mm	10-00115006	●



- **compression gland** (for pump Ø 53 mm)

	part no.	
G 2" male, with hinged clamp, stainless steel	11-00000548	●
M 64 x 4, with hinged clamp, stainless steel	11-00000549	●
external thread R 2, electrically conductive, PP	10-00114091	●



- **suction strainer S** (stainless steel)

	part no.	
for pump Ø 53 mm	11-00000186	●



- **discharge spout**, material stainless steel 316 Ti

connection	part no.	
G 1 1/2" male	10-95907043	●



FES fume glands for VISCOPOWER

consisting of valve part and threaded ring (please order both parts for a complete unit)

- **valve part S** (stainless steel) for pump Ø 53 mm, with FEP O-ring with G 3/8" female connection

	part no.	
with ball valve made of ETFE	10-00114340	●
with gas compensation connector DN 10	10-00114341	●



valve part with 3/8" BSPPF gas compensation connector

- **threaded ring S** (stainless steel), with PE flat seal

pump Ø	nominal Ø	part no.	
53 mm	G 2" male	10-00114346	●



Accessories for progressive cavity pumps in FOOD version

suitable for food contact according to Regulation (EC) 1935/2004 and FDA CFR 21



- **hose connections** in stainless steel 316 Ti, 2" clamp connection

nominal Ø	seal	part no.	
DN 32	FKM	10-95904173	●
DN 32	NBR	10-95904174	●
DN 32	PTFE	10-95904180	●
DN 38	FKM	10-95904175	●
DN 38	NBR	10-95904176	●
DN 38	PTFE	10-95904181	●



- **swaged hose fittings** for use with hose or special hose for food and chemistry, screwed version, stainless steel 316 Ti, connection pump clamp 2"

nominal Ø	seal	part no.	
DN 25	FKM	10-95913358	●
DN 25	NBR	10-95913359	●
DN 32	FKM	10-95913360	●
DN 32	NBR	10-95913361	●
DN 38	FKM	10-95913362	●
DN 38	NBR	10-95913363	●
DN 25	PTFE	10-95913388	●
DN 32	PTFE	10-95913389	●
DN 38	PTFE	10-95913390	●



- **overflow valve DN 25 in stainless steel with T-piece**, connection Clamp 2"

seal	part no.	
FKM	10-00118081	●
EPDM	10-00118083	●



- **discharge spout** in stainless steel 316 Ti

nominal Ø	part no.	
Clamp 2" (Ø 42)	10-95907036	●



- **discharge spout with check valve** in stainless steel

connection	seal	part no.	
Clamp 2"	EPDM	10-95907054	●
	FKM	10-95907055	●
	FFKM	10-95907056	●



- **flap valve** in stainless steel 1.4404, 2" clamp connection 2", DN 50

seal	part no.	
FKM	10-95919011	●
NBR	10-95919013	●



- **accessories for discharge spout** in stainless steel 316 Ti

	part no.	
holder for spout	10-00122440	●
cardan clip for clamp 2"	10-55024376	●
seal for 2" clamp, EPDM (with FDA/FOOD approval)	10-92589059	●
seal for 2" clamp, FKM (with FDA/FOOD approval)	10-92589023	●
sealing ring Clamp 2", PTFE	10-92589008	●
seal for 2" clamp, NBR (with FDA/FOOD approval)	10-92589025	●



Drive motors for progressive cavity pumps

F 580 - motor flange version

Drive motors for progressive cavity pump F 580 in motor flange version

- **three-phase motor 400 V, 50 Hz, IP 55, IE3, with motor protection switch**

	part no.	
1,5 kW, 1.000 rpm	10-00103447	●
2,2 kW, 1.000 rpm	10-00103472	●
1,1 kW, 750 rpm	10-00101591	●
1,5 kW, 750 rpm	10-00103475	●

- **three-phase motor 230/400 V, 50 Hz, IP 55, IE3, with cable terminal box**

	part no.	
1,5 kW, 1.000 rpm	10-00103446	●
2,2 kW, 1.000 rpm	10-00103471	●
1,1 kW, 750 rpm	10-00101589	●
1,5 kW, 750 rpm	10-00103474	●

- **stainless steel three-phase motor 230/400 V, 50-60 Hz, protection class IP 69k, IE3, with cable terminal box**

	part no.	
1,5 kW, 940 min ⁻¹	10-00102193	●
2,2 kW, 960 min ⁻¹	10-00102195	●

- **retaining bracket for stainless steel three-phase motors for motor flange Ø 160**

	part no.	
clear height 620 mm	10-00110640	●

- **three-phase motor 230/400 V, 50 Hz, with cable terminal box**
Ex marking Ex II 2G Ex eb IIC T3 Gb

	part no.	
0,75 kW, 1.000 rpm	10-00101122	●
1,0 kW, 1.000 rpm	10-00101123	●
1,5 kW, 1.000 rpm	10-00101125	●
0,95 kW, 750 rpm	10-00101592	●
1,3 kW, 750 rpm	10-00101593	●



- **three-phase motor VarioSwitch 200-480 V, 50-60 Hz, protection class IP 55, IE3, with speed adjustment and/or Batch operation** (requires FMO / external FLUXTRONIC® / integrated pulser and connection cable)

	part no.	
1,1 kW, 750 min ⁻¹	10-00102181	●
1,5 kW, 1.000 min ⁻¹	10-00102182	●
1,5 kW, 750 min ⁻¹	10-00102183	●
2,2 kW, 1.000 min ⁻¹	10-00102184	●
1,1 kW, 750 min ⁻¹ , for wall mounting	10-00102185	●
1,5 kW, 1.000 min ⁻¹ , for wall mounting	10-00102186	●
1,5 kW, 750 min ⁻¹ , for wall mounting	10-00102187	●
2,2 kW, 1.000 min ⁻¹ , for wall mounting	10-00102188	●

- **external digital display FLUXTRONIC®**

	part no.	
with mounting flange, without cable	10-00142113	●

- **connection cable VarioSwitch for external FLUXTRONIC®**
shielded, 2-core with 8 pole plug and wire end sleeves

	part no.	
5 m long	10-93408073	●
10 m long	10-93408074	●
15 m long	10-93408075	●

- **connection cable VarioSwitch for FMO with FLUXTRONIC®**
shielded, 2-core with 8 pole plug and wire end sleeves

	part no.	
5 m long	10-93408063	●
10 m long	10-93408064	●
15 m long	10-93408065	●



image similar



- **spur wheel back-gear motor** with frequency regulation
voltage 380 - 500 V, 50/60 Hz, IP 54, IE3, without foot flange

	A	part no.	
0,55 kW, 47 - 472 rpm	1,6	10-00102178	●

- **start / stop switch for spur wheel back-gear motor**
with frequency regulation and attached set point adjuster

		part no.	
switching voltage 24 V DC, IP 66, with 1 m spiral cable with Hirschmann plug		10-93600040	●

- **stainless steel gear motor** with cable terminal box
voltage 230/400 V, 50 Hz, protection class IP 66, IE3, without foot flange

	A	part no.	
1,5 kW, 756 min ⁻¹	3,2	10-00102196	●

- **compressed-air motor**, explosion-proof, with silencer

		part no.	
FPM 4 Ex, 0,6 kW at 1.000 rpm		10-00104000	●
FPM 6 Ex, 1,2 kW at 1.000 rpm		10-00104014	●
FPM 8 Ex, 2,0 kW at 1.000 rpm		10-00104002	●



image
similar



FPM 4 Ex



Accessories for compressed-air motor FPM 4 Ex – FPM 8 Ex

- **carrying handle**, stainless steel

	part no.	
	10-00110520	●



- **filter, regulator and lubricator unit** consisting of water separator, oil mist blower, manometer, G 1/2" female connection

	part no.	
not explosion-proof	10-00110103	●
explosion-proof	10-00110116	●



- **PVC compressed-air hose**

	part no.	
DN 13, outer Ø 20 mm	10-00110008	●



- **hose coupling** in brass

	part no.	
DN 13	10-95913122	●



- **threaded nipple** in brass for hose coupling

	part no.	
DN 13 - G 1/2 A	10-95913121	●



- **hose nozzle** in brass

	part no.	
DN 13 - G 1/2 A	10-95905017	●



- **1-ear hose clip**

material	clamping range	part no.	
stainless steel	18,8 - 22,0 mm	10-95913239	●



- **fine filter sound absorber** with oil separator

	part no.	
complete with mounting bracket	10-94715005	●



Accessories for drive motors

for VISCOPOWER F 580

Accessories for three-phase motors

- **carrying handle**, stainless steel (pump unit is screwed to the carrying handle) **for pump flange Ø 120**

	part no.	
for type F 403	10-001 10584	●

- **carrying handle for motor flange Ø 160**

mounting with 2 lugs for 3-phase motors up to size 90 and max. 20 kg

	part no.	
standard version	10-001 10531	●
with mounting for ex motor protection switch	10-001 10588	●

- **carrying handle for motor flange Ø 160**

mounting with flange for 3-phase motors up to size 112M

	part no.	
separate mounting of pump and motor. Removal of the pump can be done without removal of the motor.	10-001 10598	●

- **power supply cable**

	part no.	
pre-assembled with sleeve and Cekon plug, 5 m long	10-93408020	●
pre-assembled with sleeve without plug, 5 m long	10-93408025	●
per meter	10-93408901	●
electrical mounting commutator motor	10-Z0500MKS	●
electrical mounting three-phase motor	10-Z0500DKS	●

- **cekon plug**

	part no.	
5-poles	10-93701014	●
5-poles with commutator	10-93701035	●

- **CEE round pin plug**, for applications in Zone 1, 5-poles, 380 - 415 V (CEAG), 240 - 415 V (Stahl)

system	part no.	
CEAG, Ex-marking: II 2 G Ex db eb IIC/IIB+H2 T6	10-93701029	●
Stahl, Ex-marking: II 2 G Ex eb IIC T6...T5 Gb	10-93701048	●

- **CEE socket**, for applications in Zone 1, 5-poles 380 - 415 V (CEAG), 240 - 415 V (Stahl)

system	part no.	
CEAG, Ex-marking: II 2 G Ex eb IIC T6	10-93750040	●
Stahl, Ex-marking: II 2 G Ex eb IIC T6...T5 Gb	10-93750066	●

- **motor protection switch**, for applications in Zone 1, Ex-marking II 2 G Ex d e IIC T5 Gb, with 2 cable inlet ports, for mounting on the carrying handle

	part no.	
0,75 kW, 700 rpm, 1,6-2,5 A	10-93606118	●
0,75 kW, 930 rpm, 1,6-2,5 A		
0,95 kW, 700 rpm, 2,5-4,0 A	10-93606119	●
1,1 kW, 930 rpm, 2,5-4,0 A		
1,3 kW, 4,0-6,3 A	10-93606120	●

- **earth wire with crocodile clip**

	cable cross-section	length	forceps	part no.	
spiral cable (yellow)	3 mm ²	4 m	stainless steel	10-93190023	●
cable (green/yellow)	4 mm ²	2 m	steel zinc-plated	10-93190015	●

- **motor protection switch**, jet-proof acc. to IP 65 with 2 cable inlet ports

	part no.	
1,30 - 2,00 A, size 71	10-93606210	●
1,30 - 2,00 A, size 80 + 90	10-93606211	●
1,80 - 3,00 A, size 80 + 90	10-93606212	●
1,80 - 3,00 A, size 100 + 112	10-93606213	●
2,80 - 4,60 A, size 100 + 112	10-93606214	●
4,20 - 6,70 A, size 100 + 112	10-93606215	●
6,20 - 10,00 A, size 100 + 112	10-93606216	●

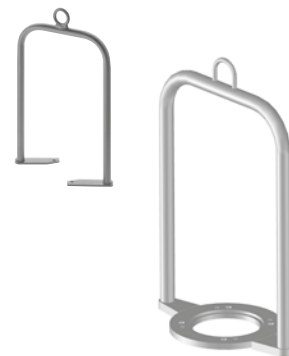

Progressive cavity pumps F 580 for dry installation (TR)



VISCOPOWER pumps F 580 with motor flange

- **open mechanical seal**, FKM seal, stator material PTFE, cardan shaft

immersion depth	rotor geometry	connection pump tube	part no.
400 mm	R52	Clamp	12-58000019 ●



- **open mechanical seal, ex-protected**, NBR seal, stator material PTFE ATEX, cardan shaft, with ex approval, ex marking II 1/2 G Ex h IIB T4...T3 Ga/Gb



immersion depth	rotor geometry	connection pump tube	part no.
400 mm	R52	Clamp	12-58000021 ●

- **closed mechanical seal**, FKM seal, stator material PTFE, cardan shaft, for food contact according to regulation (EC) 1935/2004 and FDA CFR 21



immersion depth	rotor geometry	connection pump tube	part no.
400 mm	R52	Clamp	12-58000020 ●

Drive motors with foot flange

- **three-phase motor** 400 V, 50 Hz, IP 55, motor protection switch, without cable

	A	part no.
1,1 kW, 1.000 rpm	2,85	10-00103448 ●
2,2 kW, 1.000 rpm	5,00	10-00103473 ●
0,75 kW, 750 rpm	2,10	10-00102176 ●
1,5 kW, 750 rpm	4,15	10-00103476 ●



F 580 TR

- **three-phase motor** 230 / 400 V, 50 Hz, IP 55, cable terminal box, without cable ex-marking Ex II 2G Ex eb IIC T3 Gb



	A	part no.
1,5 kW, 1.000 rpm	3,80	10-00101126 ●
1,3 kW, 750 rpm	4,25	10-00101594 ●



image similar

- **stainless steel three-phase motor** 230/400 V, 50-60 Hz, protection class IP 69k, IE3, with cable terminal box

	part no.
1,5 kW, 940 min ⁻¹	10-00102192 ●
2,2 kW, 960 min ⁻¹	10-00102194 ●

- **spur wheel back-geared motor with frequency regulation** voltage 380 - 500 V, 50/60 Hz, IP 54

	A	version	part no.
0,55 kW, 47 - 472 rpm	1,60	without foot flange	10-00102178 ●
		with foot flange	10-00102179 ●

- **start / stop switch for spur wheel back-geared motor** with frequency regulation and attached set point adjuster

	part no.
switching voltage 24 V DC, IP 66, with 1 m spiral cable	10-93600040 ●

other motors on request

Base plate and pump trolley

	part no.
stainless steel base plate	10-00115065 ●
stainless steel pump trolley with electrically conductive rollers	10-00115051 ●

- **fixing support**

for motor mounted on pump trolley or base plate	part no.
	10-00115037 ●

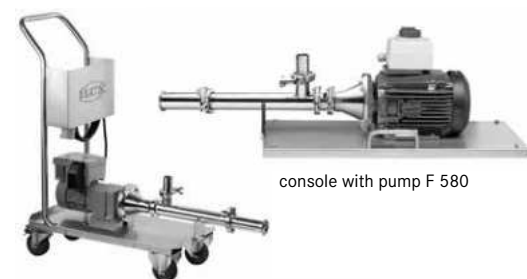

console with pump F 580

Pump trolley with pump F 580



other TR versions on request

Drum-emptying systems

VISCOFLUX



VISCOFLUX lite

For transferring high-viscosity media that are just capable of flowing

Consisting of: pump centring plate and follower plate with flexible process seal

For use with FLUX progressive cavity pump VISCOPOWER, 1.000 mm long, diameter 53 mm

Designed for 200 liter ISO drum with an inside diameter of 571,5 mm

VISCOFLUX lite

	part no.	
pump centring plate (PE) and follower plate (stainless steel 316 Ti, 6 hole pattern)	10-00122470	●

suitable process seals (6 hole pattern)

	part no.	
NBR white	10-92589081	●
NBR black	10-92589006	●
FKM	10-92589007	●
EPDM	10-92589072	●



VISCOFLUX lite Ex

Ex-marking: II 1G Ex h IIB T6...T4 Ga

	part no.	
pump centring plate (PE conductive) and follower plate (stainless steel, 5 hole pattern)	10-00122480	●

suitable set of seals (comprising process seal and O-ring)

	part no.	
NBR conductive	10-92589065	●
EPDM conductive	10-92589066	●



illustration with pump and motor

suitable pumps see page 42, 45, 46

VISCOFLUX mobile S

The stand-alone solution for transferring high-viscosity fluids



The portable drum emptying system for ISO drums with lid. Consisting of a process device with integrated moving sledge and lifting sledge as well as a driving unit. The process device is complete in stainless steel and with protection class IP 66.

The drum emptying system is available for the following drums:

- cylindrical with internal diameter 571,5 mm
- cylindrical with internal diameter 560 mm
- conical with internal diameter top 550 mm, bottom 515 mm
- with a smaller opening at the top 540 mm, bottom 571,5 mm (sea containers drums)

• **process device for three-phase motors**

version PFC-S (Pharma, Food, Cosmetic)	part no.
with trolley 470 mm for euro pallets	10-00122425 ●
with trolley 890 mm for freestanding drums and universal pallets for 4 drums	10-00122426 ●

• **process device for compressed-air motors**

version PFC-S (Pharma, Food, Cosmetic)	part no.
with trolley 470 mm for euro pallets	10-00122456 ●
with trolley 890 mm for freestanding drums and universal pallets for 4 drums	10-00122457 ●

• **follower plate in stainless steel (without process seal)**

	part no.
for drums Ø 560 mm and Ø 571,5 mm	10-00122324 ●
for conical drums Ø 550 mm above, Ø 515 mm below	10-00122304 ●
for drums with smaller opening at the top Ø 540 mm, below Ø 571 mm	10-00122357 ●

• **follower plate in stainless steel with Inliner suction protection (without process seal)**

	part no.
for drums Ø 560 mm and Ø 571,5 mm	10-00122393 ●
for conical drums Ø 550 mm above, Ø 515 mm below	10-00122394 ●

• **process seals**

for drum type	material	regulation	part no.
Ø 560 mm	FKM		10-92589030 ●
Ø 560 mm	NBR white	FDA conform, (EC) No. 1935/2004	10-92589077 ●
Ø 560 mm	NBR white	FDA conform, (EC) No. 1935/2004	10-92589068 ●
Ø 571 mm	FKM		10-92589031 ●
Ø 571 mm	NBR white	FDA conform, (EC) No. 1935/2004	10-92589078 ●
Ø 571 mm	NBR white	FDA conform, (EC) No. 1935/2004	10-92589069 ●
conical drum	NBR white	FDA conform, (EC) No. 1935/2004	10-92589079 ●
conical drum	NBR white	FDA conform, (EC) No. 1935/2004	10-92589070 ●
with smaller opening	NBR white	FDA conform, (EC) No. 1935/2004	10-92589080 ●
with smaller opening	NBR white	FDA conform, (EC) No. 1935/2004	10-92589071 ●

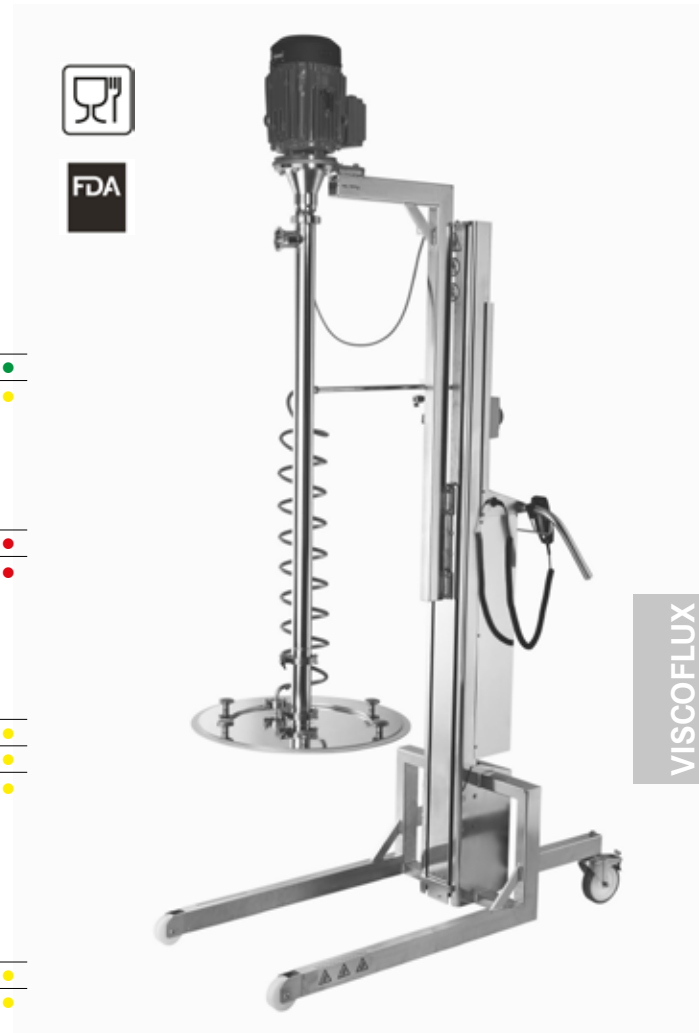

illustration with pump and motor

VISCOFLUX

suitable pumps see page 60

• **optional accessories for VISCOFLUX mobile S**

blind cover clamp for follower plate	part no.	
Clamp DN 10	10-00122355	●
Clamp 2"	10-00122356	●
trolley (interchangeable)	part no.	
470 mm	10-00122431	●
890 mm	10-00122432	●



blind cover

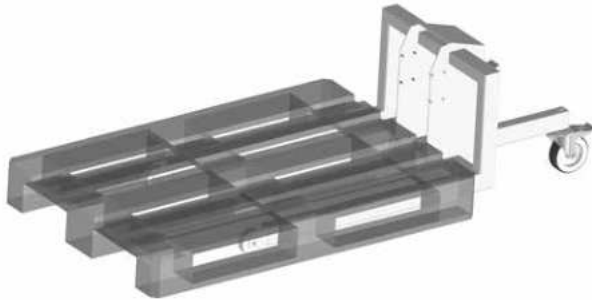

trolley 470 mm for drums on europallets



trolley 890 mm for freestanding drums and for universal pallets for 4 barrels

Control options VISCOFLUX mobile S

- **with motor protection switch, protection class IP 65**
with main / emergency stop switch

	adjustment range	part no.	
without no-volt protection	1,8 - 3,0 A	10-93606196	●
	2,8 - 4,6 A	10-93606197	●
	4,2 - 6,7 A	10-93606204	●
with no-volt protection	1,8 - 3,0 A	10-93606198	●
	2,8 - 4,6 A	10-93606199	●

- **frequency inverter for three-phase and gear motors with cable terminal box for speed adjustment with motor start/stop button, with end position warning light, with emergency switch**

	part no.	
frequency inverter 2.2 kW	10-93606223	●

- **cabinet for three-phase motors with 400 V without speed control with motor start/stop button, with end position warning light, with emergency switch**

	part no.	
without FLUXTRONIC®	10-93613028	●
with FLUXTRONIC® for batch operation	10-93613029	●

- **cabinet for spur-gear motor with frequency converter with 400 V with speed control, with motor start/stop button, with end position warning light, with emergency switch**

	part no.	
without FLUXTRONIC®	10-93613030	●
with FLUXTRONIC® for batch operation	10-93613031	●

- **optional accessory for VISCOFLUX mobile S with cabinet**
end position switch with tension spring and fixing support, protection class IP 67

nominal voltage	nominal current	part no.
max. 400 V	max. 4 A	10-00122447 ●



end position switch

Hoses

- DN 38, outer Ø 51 mm, (product sold by meter – we recommend 3 m)

	operating pressure max.	part no.	
petroleum hose	25 bar	10-00110004	●
special foodgrade hose	16 bar	10-00110119	●
hose for food and chemistry	16 bar	10-00110086	●



Swaged hose fittings DN 38

material	nominal Ø	seal	part no.	
brass	G 1 1/2" female		10-95913143	●
stainless steel	G 1 1/2" female		10-95913147	●
stainless steel	Clamp 2"	FKM (FOOD)	10-95913362	●
stainless steel	Clamp 2"	NBR (FOOD)	10-95913363	●



Discharge spout

- in stainless steel 316 Ti, suitable for food contact according to regulation (EC) 1935/2004 and FDA CFR 21

	nominal Ø	part no.	
with holder	Clamp 2"	10-95907046	●
without holder	Clamp 2"	10-95907036	●



- accessories for discharge spout

	part no.	
holder for spout	10-00122440	●
cardan clip for Clamp 2"	10-55024376	●
seal for Clamp 2", EPDM (with FDA/FOOD approval)	10-92589059	●
seal for Clamp 2", FKM (with FDA/FOOD approval)	10-92589023	●
sealing ring Clamp 2", PTFE	10-92589008	●
sealing ring Clamp 2", NBR white (with FDA/FOOD approval)	10-92589025	●



Discharge spout

- in stainless steel 316 Ti, for non-food contact

	nominal Ø	part no.	
without holder	G 1 1/2" A female	10-95907043	●



suitable digital display FLUXTRONIC® suitable for VISCOPOWER pumps F 580 with motor flange and integrated pulser

	part no.	
with mounting flange, without cable	10-00142113	●



sensor cable for VISCOPOWER with pulser

	part no.	
5 m long, for connection of sensor and evaluation unit FLUXTRONIC®	11-00000192	●



Progressive cavity pumps VISCOPOWER

for VISCOFLUX mobile S

Progressive cavity pumps VISCOPOWER F 580 with motor flange

- **open mechanical seal**, FKM seal, torsion shaft, stator material NBR

immersion depth	rotor geometry	speed sensor	part no.	
1.000 mm	R52	no	12-58000034	●
1.200 mm	R52	yes	12-58000058	●

- **open mechanical seal**, FKM seal, torsion shaft, stator material PTFE

immersion depth	rotor geometry	speed sensor	part no.	
1.200 mm	R52	no	12-58000073	●

- **closed mechanical seal**, FKM seal, torsion shaft, stator material NBR, suitable for food contact according to Regulation (EC) 1935/2004 and FDA CFR 21



immersion depth	rotor geometry	speed sensor	part no.	
1.000 mm	R52	no	12-58000041	●
1.200 mm	R52	no	12-58000057	●
1.200 mm	R52	yes	12-58000060	●

- **closed mechanical seal**, FKM seal, torsion shaft, stator material PTFE, suitable for food contact according to Regulation (EC) 1935/2004 and FDA CFR 21



immersion depth	rotor geometry	speed sensor	part no.	
1.000 mm	R52	no	12-58000061	●
1.200 mm	R52	no	12-58000024	●
1.200 mm	R52	yes	12-58000098	●

VISCOFLUX

Drive motors for VISCOFLUX mobile S

- **three-phase motors 230 / 400 V, 50 Hz, jet-proof to IP 55, IE3, with cable terminal box**

	A	part no.	
1,5 kW, 1.000 min ⁻¹	3,60	10-00103446	●
2,2 kW, 1.000 min ⁻¹	5,00	10-00103471	●
1,1 kW, 750 min ⁻¹	3,05	10-00101589	●
1,5 kW, 750 min ⁻¹	4,15	10-00103474	●



image similar

- **stainless steel three-phase motor 230/400 V, 50-60 Hz, protection class IP 69k, IE3, with cable terminal box**

	A	part no.	
1,5 kW, 940 min ⁻¹	3,50	10-00102193	●
2,2 kW, 960 min ⁻¹	5,06	10-00102195	●

- **spur wheel back-gear motor**

400 V, 100 Hz, jet-proof to IP 54, IE3

(The setpoint adjuster for control cabinet mounting is not included)

kW	A	part no.	
0,75, 82-817 min ⁻¹	1,90	10-00102180	●

- **stainless steel gear motor with cable terminal box**

voltage 230/400 V, 50 Hz, protection class IP 66, IE3, without foot flange

	A	part no.	
1,5 kW, 756 min ⁻¹	3,2	10-00102196	●

- **compressed-air motor, explosion-proof, with exhaust silencer**

	part no.	
FPM 4 Ex, 0,6 kW at 1.000 rpm	10-00104000	●
FPM 6 Ex, 1,2 kW at 1.000 rpm	10-00104014	●
FPM 8 Ex, 2,0 kW at 1.000 rpm	10-00104002	●



FPM 4 Ex

Flow meter FMC

nutating disc type



Flow meter FMC

nutating disc type

Flow meter for applications in Zone 1, Ex-marking II 2 G Ex ia IIB T6 Gb



FLUX flow meters in impulse version without digital display FLUXTRONIC® do not need an Ex certification, because this is a component that has no own potential source of ignition.

FMC 100, material: polypropylene (PP)

for portable use with drum pumps

- with digital display FLUXTRONIC®, thread connection: inlet G 1¼" female, outlet G 1¼" male

	O-ring	part no.	
FMC 100/PP/0/F	EPDM	10-A0400005	●
FMC 100/PP/1/F	FKM	10-A0400007	●
FMC 100/PP/2/F	FEP	10-A0400009	●

- impulse version without digital display, for use with hand nozzle, with impulse cable, 5 m long, thread connection inlet G 1¼" female, outlet G 1¼" male

	O-ring	part no.	
FMC 100/PP/0/F	EPDM	10-A0400035	●
FMC 100/PP/1/F	FKM	10-A0400037	●
FMC 100/PP/2/F	FEP	10-A0400039	●

- hand nozzle polypropylene (PP) with digital display FLUXTRONIC®

nominal Ø	O-ring	part no.	
DN 19	FKM	10-00112531	●
DN 25	FKM	10-00112535	●
DN 25, Ø 28	FKM	10-00112565	●

for stationary use - fixed installation into pipeline

- with digital display FLUXTRONIC®, thread connection on both sides G 1½" male

	O-ring	part no.	
FMC 100/PP/0/A	EPDM	10-A0400012	●
FMC 100/PP/1/A	FKM	10-A0400014	●
FMC 100/PP/2/A	FEP	10-A0400016	●

- impulse version without digital display, for use with external digital display FLUXTRONIC®, with impulse cable, 5 m long, thread connection on both sides G 1½" male

	O-ring	part no.	
FMC 100/PP/0/A	EPDM	10-A0400041	●
FMC 100/PP/1/A	FKM	10-A0400043	●
FMC 100/PP/2/A	FEP	10-A0400045	●

external digital display FLUXTRONIC® see page 62

FMC 100, material: ethylene-tetrafluorethylene (ETFE)

for portable use with drum pumps

- with digital display FLUXTRONIC®, thread connection: inlet G 1¼" female, outlet G 1¼" male

	O-ring	part no.	
FMC 100/ETFE/0/F	EPDM	10-A0400006	●
FMC 100/ETFE/1/F	FKM	10-A0400008	●
FMC 100/ETFE/3/F	FFKM	10-A0400077	●

- impulse version without digital display, for use with hand nozzle, with impulse cable, 5 m long, thread connection inlet G 1¼" female, outlet G 1¼" male

	O-ring	part no.	
FMC 100/ETFE/0/F	EPDM	10-A0400036	●
FMC 100/ETFE/1/F	FKM	10-A0400038	●
FMC 100/ETFE/3/F	FFKM	10-A0400079	●

- hand nozzle polyvinylidene fluoride (PVDF) with digital display FLUXTRONIC®

connection	O-ring	part no.	
DN 19	FKM	10-00112532	●
DN 25	FKM	10-00112536	●
DN 25, Ø 28	FKM	10-00112566	●



for stationary use - fixed installation into pipeline

- with digital display FLUXTRONIC®, thread connection on both sides G 1½" male

	O-ring	part no.	
FMC 100/ETFE/0/A	EPDM	10-A0400013	●
FMC 100/ETFE/1/A	FKM	10-A0400015	●
FMC 100/ETFE/3/A	FFKM	10-A0400078	●

- impulse version without digital display, for use with external digital display FLUXTRONIC®, with impulse cable, 5 m long, thread connection on both sides G 1½" male

	O-ring	part no.	
FMC 100/ETFE/0/A	EPDM	10-A0400042	●
FMC 100/ETFE/1/A	FKM	10-A0400044	●
FMC 100/ETFE/3/A	FFKM	10-A0400080	●

external digital display FLUXTRONIC® see page 62



FMC 100, material: stainless steel (S)

for portable use with drum pumps

- with digital display FLUXTRONIC®, thread connection: inlet G 1½" male, outlet G 1¼" male

	O-ring	part no.	
FMC 100/S/0/F	EPDM	10-A0400029	●
FMC 100/S/1/F	FKM	10-A0400031	●
FMC 100/S/2/F	FEP	10-A0400033	●

- impulse version without digital display, for use with hand nozzle, with impulse cable, 5 m long, thread connection inlet G 1¼" male, outlet G 1¼" male

	O-ring	part no.	
FMC 100/S/0/F	EPDM	10-A0400053	●
FMC 100/S/1/F	FKM	10-A0400055	●
FMC 100/S/2/F	FEP	10-A0400057	●

- hand nozzle stainless steel (S) with digital display FLUXTRONIC®

nominal Ø	O-ring	part no.	
Ø 28	PTFE/FEP	10-00112550	●

- hand nozzle nickel-plated brass (MS) with digital display FLUXTRONIC®

nominal Ø	O-ring	part no.	
Ø 32	PTFE	10-00112364	●

- connecting piece in stainless steel

	nominal Ø	part no.	
for FLUX drum pumps	G 1¼" female - G 1½" female	10-95906059	●
for FLUX progressive cavity pumps	G 1½" female - G 1½" female	10-95906061	●



for stationary use - fixed installation into pipeline, with digital display FLUXTRONIC®

- G 1" female thread connection on both sides

	O-ring	part no.	
FMC 100/S/0/A	EPDM	10-A0400085	●
FMC 100/S/1/A	FKM	10-A0400086	●
FMC 100/S/2/A	FEP	10-A0400087	●

- thread connection on both sides G 1½" male

	O-ring	part no.	
FMC 100/S/0/A	EPDM	10-A0400071	●
FMC 100/S/1/A	FKM	10-A0400072	●
FMC 100/S/2/A	FEP	10-A0400073	●



Flow meter FMC/FMJ

nutating disc type

- flange connector on both sides outer Ø 115 mm, PC Ø 85 mm, 4 bores Ø 14 mm

	O-ring	part no.	
FMC 100/S/0/A	EPDM	10-A0400082	●
FMC 100/S/1/A	FKM	10-A0400083	●
FMC 100/S/2/A	FEP	10-A0400084	●

- thread connection on both sides Rd 65 x 1/6

	O-ring	part no.	
FMC 100/S/0/A	EPDM	10-A0400023	●
FMC 100/S/1/A	FKM	10-A0400025	●
FMC 100/S/2/A	FEP	10-A0400027	●

impulse version without digital display

for use with external digital display FLUXTRONIC®, with impulse cable, 5 m long

- thread connection on both sides G 1¼" male

	O-ring	part no.	
FMC 100/S/0/A	EPDM	10-A0400074	●
FMC 100/S/1/A	FKM	10-A0400075	●
FMC 100/S/2/A	FEP	10-A0400076	●

- thread connection on both sides Rd 65 x 1/6

	O-ring	part no.	
FMC 100/S/0/A	EPDM	10-A0400059	●
FMC 100/S/1/A	FKM	10-A0400061	●
FMC 100/S/2/A	FEP	10-A0400063	●

external digital display FLUXTRONIC®

	part no.	
with mounting flange, without cable	10-00142113	●



FMC 250, for stationary use – fixed installation into pipeline, with digital display FLUXTRONIC®

- polypropylene, thread connection on both sides, G 2¼" male

	O-ring	part no.	
FMC 250/PP/0/A	EPDM	10-A0425400	●
FMC 250/PP/1/A	FKM	10-A0425410	●

- polyvinylidene fluoride, thread connection on both sides G 2¼" male

	O-ring	part no.	
FMC 250/PVDF/0/A	EPDM	10-A0425600	●
FMC 250/PVDF/1/A	FKM	10-A0425610	●



FMJ 100, material polypropylene, with digital display FLUXTRONIC®, for flexible use with drum pumps and for manual use (no batch-control possible), not explosion-proof

- thread connection inlet G 2" male, outlet G 1¼" male (with connecting piece)

	O-ring	part no.	
FMJ 100/PP/1/F	FKM	10-A0400088	●



Accessories for FMC see page 72-73

Connectors (according to standards) for pipeline construction on request

Flow meter FMO

oval rotor type



Flow meter FMO

oval rotor type

FMO 101 and FMO 102

with impulse output, without digital display FLUXTRONIC®,
in PVDF, thread connection both sides G ¼ female, Reed/Hall Sensor

- for thin-flowing substances up to 1.000 cP

	housing	oval rotors	O-ring	part no.	
FMO 101/P/P/0	PVDF	PPS	EPDM	10-AB601400	●
FMO 101/P/P/1	PVDF	PPS	FKM	10-AB601410	●
FMO 101/P/P/2	PVDF	PPS	FFKM	10-AB601420	●
FMO 101/P/S/0	PVDF	S	EPDM	10-AB601100	●
FMO 101/P/S/1	PVDF	S	FKM	10-AB601110	●
FMO 101/P/S/2	PVDF	S	FFKM	10-AB601120	●
FMO 102/P/P/0	PVDF	PPS	EPDM	10-AB602400	●
FMO 102/P/P/1	PVDF	PPS	FKM	10-AB602410	●
FMO 102/P/P/2	PVDF	PPS	FFKM	10-AB602420	●
FMO 102/P/S/0	PVDF	S	EPDM	10-AB602100	●
FMO 102/P/S/1	PVDF	S	FKM	10-AB602110	●
FMO 102/P/S/2	PVDF	S	FFKM	10-AB602120	●



- connecting piece for FMO 101 and FMO 102 in PVDF

double nipple (only in conjunction with one of the following flat seals)

	material	connection	part no.	
	PVDF	G ¼" male	10-95906259	●
	material		part no.	
flat seal	HD-PE		10-92524015	●
flat seal	FKM		10-92524016	●
flat seal	FFKM		10-92524017	●
flat seal	PTFE		10-92524018	●

FMO 101 and FMO 102 for applications in Zone 1

Ex-marking II 2G Ex h IIB T4 Gb

with impulse output, without digital display FLUXTRONIC®,
in stainless steel (S), thread connection G ¼, Reed/Hall sensor
(in hazardous areas only with Reed sensor)

- for thin-flowing substances up to 1.000 cP

	housing	oval rotors	O-ring	part no.	
FMO 101/S/S/0	S	S	EPDM	10-AB601300	●
FMO 101/S/S/1	S	S	FKM	10-AB601310	●
FMO 101/S/S/2	S	S	FFKM	10-AB601320	●
FMO 102/S/S/0	S	S	EPDM	10-AB602300	●
FMO 102/S/S/1	S	S	FKM	10-AB602310	●
FMO 102/S/S/2	S	S	FFKM	10-AB602320	●

- digital display FLUXTRONIC® for FMO 101 and FMO 102

Ex-marking Ex II 2G Ex ia IIB T6 Gb

	part no.	
with attachment flange and 5 m impulse cable with plug	10-00142111	●

- connecting piece for FMO 101 and FMO 102 in stainless steel

double nipple (only in conjunction with one of the following flat seals)

	material	connection	part no.	
	S	G ¼" male	10-95906262	●



FMO 104 for applications in Zone 1

Ex-marking FMO II 2G Ex h IIB T4 Gb, Ex-marking FLUXTRONIC® II 2G Ex ia IIB T6 Gb, in aluminium (AL) or stainless steel (S), thread connection both sides G 1/2 female, Reed/Reed Sensor

for thin-flowing substances up to 1.000 cP

- with digital display FLUXTRONIC®, 5-pole socket

	housing	oval rotors	O-ring	part no.	
FMO 104/AL/P/0	AL	PPS	EPDM	10-A0604100	●
FMO 104/AL/P/1	AL	PPS	FKM	10-A0604110	●
FMO 104/AL/P/2	AL	PPS	FFKM	10-A0604120	●
FMO 104/S/P/0	S	PPS	EPDM	10-A0604200	●
FMO 104/S/P/1	S	PPS	FKM	10-A0604210	●
FMO 104/S/P/2	S	PPS	FFKM	10-A0604220	●
FMO 104/S/S/0	S	S	EPDM	10-A0604300	●
FMO 104/S/S/1	S	S	FKM	10-A0604310	●
FMO 104/S/S/2	S	S	FFKM	10-A0604320	●



FMO 104 with FLUXTRONIC®

- impulse version, without digital display FLUXTRONIC®

	housing	oval rotors	O-ring	part no.	
FMO 104/AL/P/0	AL	PPS	EPDM	10-AB604100	●
FMO 104/AL/P/1	AL	PPS	FKM	10-AB604110	●
FMO 104/AL/P/2	AL	PPS	FFKM	10-AB604120	●
FMO 104/S/P/0	S	PPS	EPDM	10-AB604200	●
FMO 104/S/P/1	S	PPS	FKM	10-AB604210	●
FMO 104/S/P/2	S	PPS	FFKM	10-AB604220	●
FMO 104/S/S/0	S	S	EPDM	10-AB604300	●
FMO 104/S/S/1	S	S	FKM	10-AB604310	●
FMO 104/S/S/2	S	S	FFKM	10-AB604320	●

for high viscosity substances from 1.000 cP

- with digital display FLUXTRONIC®, 5-pole socket

	housing	oval rotors	O-ring	part no.	
FMO 104/AL/PV/0	AL	PPS	EPDM	10-A0604105	●
FMO 104/AL/PV/1	AL	PPS	FKM	10-A0604115	●
FMO 104/AL/PV/2	AL	PPS	FFKM	10-A0604125	●
FMO 104/S/PV/0	S	PPS	EPDM	10-A0604205	●
FMO 104/S/PV/1	S	PPS	FKM	10-A0604215	●
FMO 104/S/PV/2	S	PPS	FFKM	10-A0604225	●
FMO 104/S/SV/0	S	S	EPDM	10-A0604305	●
FMO 104/S/SV/1	S	S	FKM	10-A0604315	●
FMO 104/S/SV/2	S	S	FFKM	10-A0604325	●

- in impulse version, without digital display FLUXTRONIC®

	housing	oval rotors	O-ring	part no.	
FMO 104/AL/PV/0	AL	PPS	EPDM	10-AB604105	●
FMO 104/AL/PV/1	AL	PPS	FKM	10-AB604115	●
FMO 104/AL/PV/2	AL	PPS	FFKM	10-AB604125	●
FMO 104/S/PV/0	S	PPS	EPDM	10-AB604205	●
FMO 104/S/PV/1	S	PPS	FKM	10-AB604215	●
FMO 104/S/PV/2	S	PPS	FFKM	10-AB604225	●
FMO 104/S/SV/0	S	S	EPDM	10-AB604305	●
FMO 104/S/SV/1	S	S	FKM	10-AB604315	●
FMO 104/S/SV/2	S	S	FFKM	10-AB604325	●



FMO 104 in impulse version

- connecting pieces for FMO 104

FLUX drum pump - FMO 104

for use with	material	connection	part no.	
FLUX drum pumps	S	G 1 1/2" male - G 1 1/4" female	10-95906227	●
FLUX progressive cavity pumps	S	G 1 1/2" male - G 1 1/2" female	10-95906225	●

FMO 104 - hose connection

for use with	material	connection	part no.	
hose connection drum pumps	S	G 1/2" male - G 1 1/4" male	10-95906232	●
hose connection progressive cavity pumps	S	G 1/2" male - G 1 1/2" male	10-95906233	●

double nipple

	material	connection	part no.	
	S	G 1/4" male	10-95906263	●

Flow meter FMO

oval rotor type

FMO 110

in PVDF, thread connection on both sides G 1" female, Reed/Reed sensor

for thin-flowing substances up to 1.000 cP

- with digital display FLUXTRONIC®, 5-pole socket

	housing	oval rotors	O-ring	part no.	
FMO 110/P/P/0	PVDF	PPS	EPDM	10-A0610400	●
FMO 110/P/P/1	PVDF	PPS	FKM	10-A0610410	●
FMO 110/P/P/2	PVDF	PPS	FFKM	10-A0610420	●

- impulse version, without digital display FLUXTRONIC®

	housing	oval rotors	O-ring	part no.	
FMO 110/P/P/0	PVDF	PPS	EPDM	10-AB610400	●
FMO 110/P/P/1	PVDF	PPS	FKM	10-AB610410	●
FMO 110/P/P/2	PVDF	PPS	FFKM	10-AB610420	●

- connecting pieces for FMO 110 in PVDF

FLUX-pump - FMO 110

for use with	material	connection	part no.	
drum pump	PVDF	G 1 male - G 1¼ female	10-95906145	●
hose connection drum pump	PVDF	G 1 male - G ¼ male	10-95906236	●

double nipple (only in conjunction with one of the following flat seals)

	material	connection	part no.	
	PVDF	G 1 male	10-95906261	●

	material	part no.	
flat seal	HD-PE	10-92564028	●
flat seal	FKM	10-92564029	●
flat seal	FFKM	10-92564030	●
flat seal	PTFE	10-92564031	●

FMO 110 for applications in Zone 1

Ex-marking FMO II 2G Ex h IIB T4 Gb, Ex-marking FLUXTRONIC® II 2G Ex ia IIB T6 Gb, in aluminium (AL) or stainless steel (S), thread connection both sides G 1 female, Reed/Reed Sensor

for thin-flowing substances up to 1.000 cP

- with digital display FLUXTRONIC®, 5-pole socket

	housing	oval rotors	O-ring	part no.	
FMO 110/AL/P/0	AL	PPS	EPDM	10-A0610100	●
FMO 110/AL/P/1	AL	PPS	FKM	10-A0610110	●
FMO 110/AL/P/2	AL	PPS	FFKM	10-A0610120	●
FMO 110/S/P/0	S	PPS	EPDM	10-A0610200	●
FMO 110/S/P/1	S	PPS	FKM	10-A0610210	●
FMO 110/S/P/2	S	PPS	FFKM	10-A0610220	●
FMO 110/S/S/0	S	S	EPDM	10-A0610300	●
FMO 110/S/S/1	S	S	FKM	10-A0610310	●
FMO 110/S/S/2	S	S	FFKM	10-A0610320	●

- impulse version, without digital display FLUXTRONIC®

	housing	oval rotors	O-ring	part no.	
FMO 110/AL/P/0	AL	PPS	EPDM	10-AB610100	●
FMO 110/AL/P/1	AL	PPS	FKM	10-AB610110	●
FMO 110/AL/P/2	AL	PPS	FFKM	10-AB610120	●
FMO 110/S/P/0	S	PPS	EPDM	10-AB610200	●
FMO 110/S/P/1	S	PPS	FKM	10-AB610210	●
FMO 110/S/P/2	S	PPS	FFKM	10-AB610220	●
FMO 110/S/S/0	S	S	EPDM	10-AB610300	●
FMO 110/S/S/1	S	S	FKM	10-AB610310	●
FMO 110/S/S/2	S	S	FFKM	10-AB610320	●



FMO 110 in impulse version



FMO 110 with FLUXTRONIC®



FMO 110 in impulse version

Additional price 60,00 € for FMO 104-150 with platine with Hall-Sensor instead of platine with Reed/Reed

not suitable for use in hazardous areas

for high viscosity substances from 1.000 cP

- with digital display FLUXTRONIC®, 5-pole socket

	housing	oval rotors	O-ring	part no.	
FMO 110/AL/PV/0	AL	PPS	EPDM	10-A0610105	●
FMO 110/AL/PV/1	AL	PPS	FKM	10-A0610115	●
FMO 110/AL/PV/2	AL	PPS	FFKM	10-A0610125	●
FMO 110/S/PV/0	S	PPS	EPDM	10-A0610205	●
FMO 110/S/PV/1	S	PPS	FKM	10-A0610215	●
FMO 110/S/PV/2	S	PPS	FFKM	10-A0610225	●
FMO 110/S/SV/0	S	S	EPDM	10-A0610305	●
FMO 110/S/SV/1	S	S	FKM	10-A0610315	●
FMO 110/S/SV/2	S	S	FFKM	10-A0610325	●

- pulse version, without digital display FLUXTRONIC®

	housing	oval rotors	O-ring	part no.	
FMO 110/AL/PV/0	AL	PPS	EPDM	10-AB610105	●
FMO 110/AL/PV/1	AL	PPS	FKM	10-AB610115	●
FMO 110/AL/PV/2	AL	PPS	FFKM	10-AB610125	●
FMO 110/S/PV/0	S	PPS	EPDM	10-AB610205	●
FMO 110/S/PV/1	S	PPS	FKM	10-AB610215	●
FMO 110/S/PV/2	S	PPS	FFKM	10-AB610225	●
FMO 110/S/SV/0	S	S	EPDM	10-AB610305	●
FMO 110/S/SV/1	S	S	FKM	10-AB610315	●
FMO 110/S/SV/2	S	S	FFKM	10-AB610325	●

- connecting pieces** for FMO 110 in stainless steel

FLUX drum pumps - FMO 110

for use with	material	connection	part no.	
drum pumps	S	G 1 male - G 1¼ female	10-95906144	●
progressive cavity pump	S	G 1 male - G 1½ female	10-95906122	●

FMO 110 - hose connection

for use with	material	connection	part no.	
hose connection drum pump	S	G 1 male - G 1¼ male	10-95906234	●
hose connection progressive cavity pump	S	G 1 male - G 1½ male	10-95906235	●

double nipple

	material	connection	part no.	
	S	G 1 male	10-95906264	●

Flow meter FMO

oval rotor type

FMO 110 for applications in Zone 1

Ex-marking FMO II 2G Ex h IIB T4 Gb, Ex-marking FLUXTRONIC® II 2G Ex ia IIB T6 Gb,

with flange connection, Reed/Reed sensor

for thin-flowing substances up to 1.000 cP

- with digital display FLUXTRONIC®, 5-pole socket

with flange connection PN 16 DN 25 on both sides	housing	oval rotors	O-ring	part no.	
FMO 110/S/S/1	S	S	FKM	10-A06 10111	●
FMO 110/S/S/2	S	S	FFKM	10-A06 10121	●



Image similar

with clamp connection, Reed/Reed sensor

for thin-flowing substances up to 1.000 cP, suitable for food contact according to regulation (EC) 1935/2004 and FDA CFR 21, in stainless steel (S)

- with digital display FLUXTRONIC®, 5-pole socket

clamp 1 1/2" connection on both sides	housing	oval rotors	O-ring	part no.	
FMO 110/S/S/0	S	S	EPDM	10-A06 10302	●
FMO 110/S/S/1	S	S	FKM	10-A06 10312	●

clamp 2" connection on both sides	housing	oval rotors	O-ring	part no.	
FMO 110/S/S/0	S	S	EPDM	10-A06 10303	●
FMO 110/S/S/1	S	S	FKM	10-A06 10313	●



for high viscosity substances from 1.000 cP

- with digital display FLUXTRONIC®, 5-pole socket

clamp 2" connection on both sides	housing	oval rotors	O-ring	part no.	
FMO 110/S/SV/0	S	S	EPDM	10-A06 10307	●
FMO 110/S/SV/1	S	S	FKM	10-A06 10317	●

accessories for FMO 110 with clamp connection

seal pump/ flow meter	material	part no.	
for clamp 1 1/2"	EPDM (with FDA/FOOD approval)	10-92569017	●
for clamp 1 1/2"	FKM (with FDA/FOOD approval)	10-92569014	●
for clamp 2"	EPDM (with FDA/FOOD approval)	10-92589059	●
for clamp 2"	FKM (with FDA/FOOD approval)	10-92589023	●

joint clamp	material	part no.	
for clamp 1 1/2"	stainless steel	10-43021019	●
for clamp 2"	stainless steel	10-55024376	●



FMO 140

Ex-marking FMO II 2G Ex h IIB T4 Gb, Ex-marking FLUXTRONIC® II 2G Ex ia IIB T6 Gb, in aluminium (AL) or stainless steel (S), nominal pressure PN 16, nominal flange connection DN 40, EN 1092-1, Reed/Reed sensor

for thin-flowing substances up to 1.000 cP

- with digital display FLUXTRONIC®, 5-pole socket

	housing	oval rotors	O-ring	part no.	
FMO 140/AL/P/0	AL	PPS	EPDM	10-A0640101	●
FMO 140/AL/P/1	AL	PPS	FKM	10-A0640111	●
FMO 140/AL/P/2	AL	PPS	FFKM	10-A0640121	●
FMO 140/S/P/0	S	PPS	EPDM	10-A0640201	●
FMO 140/S/P/1	S	PPS	FKM	10-A0640211	●
FMO 140/S/P/2	S	PPS	FFKM	10-A0640221	●
FMO 140/S/S/0	S	S	EPDM	10-A0640301	●
FMO 140/S/S/1	S	S	FKM	10-A0640311	●
FMO 140/S/S/2	S	S	FFKM	10-A0640321	●

for high viscosity substances from 1.000 cP

- with digital display FLUXTRONIC®, 5-pole socket

	housing	oval rotors	O-ring	part no.	
FMO 140/AL/PV/0	AL	PPS	EPDM	10-A0640106	●
FMO 140/AL/PV/1	AL	PPS	FKM	10-A0640116	●
FMO 140/AL/PV/2	AL	PPS	FFKM	10-A0640126	●
FMO 140/S/PV/0	S	PPS	EPDM	10-A0640206	●
FMO 140/S/PV/1	S	PPS	FKM	10-A0640216	●
FMO 140/S/PV/2	S	PPS	FFKM	10-A0640226	●
FMO 140/S/SV/0	S	S	EPDM	10-A0640306	●
FMO 140/S/SV/1	S	S	FKM	10-A0640316	●
FMO 140/S/SV/2	S	S	FFKM	10-A0640326	●



FMO 150

Ex-marking FMO II 2G Ex h IIB T4 Gb, Ex-marking FLUXTRONIC® II 2G Ex ia IIB T6 Gb, in aluminium (AL) or stainless steel (S), nominal pressure PN 16, nominal flange connection DN 50, EN 1092-1, Reed/Reed sensor

for thin-flowing substances up to 1.000 cP

- with digital display FLUXTRONIC®, 5-pole socket

	housing	oval rotors	O-ring	part no.	
FMO 150/AL/P/0	AL	PPS	EPDM	10-A0650101	●
FMO 150/AL/P/1	AL	PPS	FKM	10-A0650111	●
FMO 150/AL/P/2	AL	PPS	FFKM	10-A0650121	●
FMO 150/S/P/0	S	PPS	EPDM	10-A0650201	●
FMO 150/S/P/1	S	PPS	FKM	10-A0650211	●
FMO 150/S/P/2	S	PPS	FFKM	10-A0650221	●
FMO 150/S/S/0	S	S	EPDM	10-A0650301	●
FMO 150/S/S/1	S	S	FKM	10-A0650311	●
FMO 150/S/S/2	S	S	FFKM	10-A0650321	●

for high viscosity substances from 1.000 cP

- with digital display FLUXTRONIC®, 5-pole socket

	housing	oval rotors	O-ring	part no.	
FMO 150/AL/PV/0	AL	PPS	EPDM	10-A0650106	●
FMO 150/AL/PV/1	AL	PPS	FKM	10-A0650116	●
FMO 150/AL/PV/2	AL	PPS	FFKM	10-A0650126	●
FMO 150/S/PV/0	S	PPS	EPDM	10-A0650206	●
FMO 150/S/PV/1	S	PPS	FKM	10-A0650216	●
FMO 150/S/PV/2	S	PPS	FFKM	10-A0650226	●
FMO 150/S/SV/0	S	S	EPDM	10-A0650306	●
FMO 150/S/SV/1	S	S	FKM	10-A0650316	●
FMO 150/S/SV/2	S	S	FFKM	10-A0650326	●



Accessories for flow meter

- **impulse cable** for FMO 104 / FMO 110 version without digital display
2-core, both sides with wire sleeves, insulated to transmit control signal from FMO reed-relais to the external digital display FLUXTRONIC®

	part no.	
5 m long	10-93408032	●
10 m long	10-93408033	●
15 m long	10-93408034	●

- **connecting cable, shielded** for FMC / FMO to extend the impulse cable

	part no.	
5 m long with plug and coupling	10-93408039	●

- **external digital display FLUXTRONIC®**

	part no.	
with wall mounting flange, without cable	10-00142113	●

- **clear protection cover for FLUXTRONIC® display**

for	part no.	
FMJ	10-00142101	●
FMC/FMO	10-00142121	●

- **earth wire** for FMC PP and FMC ETFE to produce a conductive connection of hose connection and motor

	part no.	
1 m long	10-93190009	●

- **switching amplifier FSV 100**

		part no.	
can be integrated into flow meter, 2 signals, with power supply cable, 5 m long	230 V, 50 - 60 Hz, IP 44, 4A	10-00149040	●
connecting cable for magnetic valve	5 m long	10-93408036	●
connecting cable for motor	0,5 m long	10-93408035	●

- **power supply cable** for FSV 100

	part no.	
5 m long, without plug	10-93408047	●

- **connecting cable** to motor for FSV 100

	part no.	
0,5 m long, without coupling	10-93408057	●

- **connecting cable** to FLUXTRONIC® FSV 100

	part no.	
5 m long, 5 core, sleeve for strands on both ends	10-93408030	●
10 m long, 5 core, sleeve for strands on both ends	10-93408031	●

- **assembly output assignment FMC/FMO**

	part no.	
	10-00000251	●

- **Platine with Hall-sensor for wear-free measurement, for FMO 104 - 150,**
not suitable for use in hazardous areas

	part no.	
	10-A0604919	●



Switching amplifier with Ex input for use out of the hazardous areas

- switching amplifier FSV 132

		part no.	
for installation in switch box	2 signals, 230 V, 50 – 60 Hz, IP 20, AC - 4A, DC - 2A Ex-marking: II (1) G [Ex ia Ga] IIC	10-94004020	●
5-core control cable for the connection of flow meter or FAE	5 m long	10-93408038	●
	10 m long	10-93408040	●
	15 m long	10-93408041	●



- switching amplifier FSV 133 Ex (only for transferring impulse)

		part no.	
for installation in switch box	1 signal, Ex i entry acc. to EN 60947-5-6, electronic exit 30 V DC/50 mA Ex-marking: II 3 (1) G Ex nAc nCc [ia] IIC T4	10-94004043	●
5-core control cable for the connection of flow meter or FAE	5 m long	10-93408038	●
	10 m long	10-93408040	●
	15 m long	10-93408041	●



Switching amplifier in Ex-version, Zone 1

- switching amplifier FSV 121 Ex

		part no.	
for wall mounting with miniCLIX plug connections for network connection cable, with control cable 5 m long	1 signal, 230 V, 50 Hz, 4 A, IP 66 Ex-marking: II 2 G db eb [ia Ga] IIC T6 Gb	10-00149051	●
power supply cable	5 m long, with plug-in	10-93408062	●
connection cable to motor	5 m long	10-93408049	●



- switching amplifier FSV 121-1/2 Ex

		part no.	
for wall mounting, without plug-ins and control cable	121-1: 1 signal 230 V, 50 Hz, 4A, IP 66, Ex-marking: II 2(1) G Ex db eb [ia Ga] IIC T6 Gb	10-00149039	●
	121-2, 2 signals 230 V, 50 Hz, 4A, IP 66, Ex-marking: II 2(1) G Ex db eb [ia Ga] IIC T6 Gb	10-00149063	●
control cable for the connection of flow meter or FAE	5 m long	10-93408038	●
	10 m long	10-93408040	●
	15 m long	10-93408041	●



Flow meter

Air-operated diaphragm pumps

(RFM and FDM series)

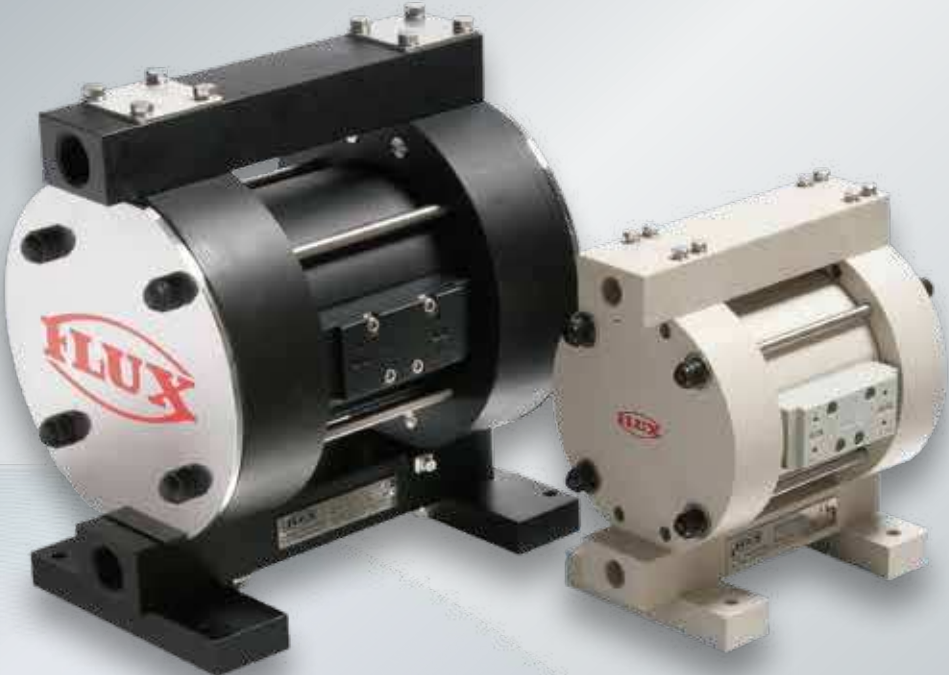

Air-operated diaphragm pumps

RFM in solid construction

RFM 10 in polypropylene (PP) or polytetrafluoroethylene (PTFE), connection pump G 3/8" female

	diaphragm/seal	part no.	
RFM 10 PP/NN	NBR	10-D1040010	●
RFM 10 PP/TK	PTFE/FFKM	10-D1040120	●
RFM 10 PP/TE	PTFE/EPDM	10-D1040130	●
RFM 10 PP/TV	PTFE/FKM	10-D1040140	●
RFM 10 PP/EE	EPDM	10-D1040210	●
RFM 10 PP/VV	FKM	10-D1040310	●
RFM 10 PTFE/TK	PTFE/FFKM	10-D1000120	●
RFM 10 PTFE/TE	PTFE/EPDM	10-D1000130	●
RFM 10 PTFE/TV	PTFE/FKM	10-D1000140	●
RFM 10 PTFE/EE	EPDM	10-D1000210	●
RFM 10 PTFE/VV	FKM	10-D1000310	●



RFM 10 in polytetrafluoroethylene (PTFE), FDA CFR 21 conform, connection pump G 3/8" female

	diaphragm/seal	part no.	
RFM 10 PTFE/TK (FDA)	PTFE/FFKM	10-D1000121	●
RFM 10 PTFE/TE (FDA)	PTFE/EPDM	10-D1000131	●



RFML 10 electrically conductive PP or PTFE, for applications in Zone 1, Ex-marking II 1/2 G Ex h IIB T6.. T4 Ga/Gb, connection pump G 3/8" female

	diaphragm/seal	part no.	
RFML 10 PP/NN	NBR	10-D1041010	●
RFML 10 PP/TK	PTFE/FFKM	10-D1041120	●
RFML 10 PP/TE	PTFE/EPDM	10-D1041130	●
RFML 10 PP/TV	PTFE/FKM	10-D1041140	●
RFML 10 PP/EE	EPDM	10-D1041210	●
RFML 10 PP/VV	FKM	10-D1041310	●
RFML 10 PTFE/TK	PTFE/FFKM	10-D1001120	●
RFML 10 PTFE/TE	PTFE/EPDM	10-D1001130	●
RFML 10 PTFE/TV	PTFE/FKM	10-D1001140	●
RFML 10 PTFE/EE	EPDM	10-D1001210	●
RFML 10 PTFE/VV	FKM	10-D1001310	●



RFML 10 electrically conductive PTFE, FDA CFR 21 conform

	diaphragm/seal	part no.	
RFML 10 PTFE/TK-FDA	PTFE/FFKM	10-D1001121	●
RFML 10 PTFE/TE-FDA	PTFE/EPDM	10-D1001131	●



RFM 15 in polypropylene (PP) or polytetrafluoroethylene (PTFE), connection pump G 1/2" female

	diaphragm/seal	part no.	
RFM 15 PP/NN	NBR	10-D1540010	●
RFM 15 PP/TK	PTFE/FFKM	10-D1540120	●
RFM 15 PP/TE	PTFE/EPDM	10-D1540130	●
RFM 15 PP/TV	PTFE/FKM	10-D1540140	●
RFM 15 PP/EE	EPDM	10-D1540210	●
RFM 15 PP/VV	FKM	10-D1540310	●
RFM 15 PTFE/TK	PTFE/FFKM	10-D1500120	●
RFM 15 PTFE/TE	PTFE/EPDM	10-D1500130	●
RFM 15 PTFE/TV	PTFE/FKM	10-D1500140	●
RFM 15 PTFE/EE	EPDM	10-D1500210	●
RFM 15 PTFE/VV	FKM	10-D1500310	●



RFM 15 in polytetrafluoroethylene (PTFE), FDA CFR 21 conform, connection pump G 1/2" female

	diaphragm/seal	part no.	
RFM 15 PTFE/TK (FDA)	PTFE/FFKM	10-D1500121	●
RFM 15 PTFE/TE (FDA)	PTFE/EPDM	10-D1500131	●



**RFML 15 electrically conductive PP or PTFE, for applications in Zone 1,
Ex-marking II 1/2 G Ex h IIB T6..T4 Ga/Gb, connection pump G 1/2" female**

	diaphragm/seal	part no.	
RFML 15 PP/NN	NBR	10-D1541010	●
RFML 15 PP/TK	PTFE/FFKM	10-D1541120	●
RFML 15 PP/TE	PTFE/EPDM	10-D1541130	●
RFML 15 PP/TV	PTFE/FKM	10-D1541140	●
RFML 15 PP/EE	EPDM	10-D1541210	●
RFML 15 PP/VV	FKM	10-D1541310	●
RFML 15 PTFE/TK	PTFE/FFKM	10-D1501120	●
RFML 15 PTFE/TE	PTFE/EPDM	10-D1501130	●
RFML 15 PTFE/TV	PTFE/FKM	10-D1501140	●
RFML 15 PTFE/EE	EPDM	10-D1501210	●
RFML 15 PTFE/VV	FKM	10-D1501310	●



RFM 25 in polypropylene (PP) or polytetrafluoroethylene (PTFE), connection pump G 1" female

	diaphragm/seal	part no.	
RFM 25 PP/NN	NBR	10-D2540010	●
RFM 25 PP/TK	PTFE/FFKM	10-D2540120	●
RFM 25 PP/TE	PTFE/EPDM	10-D2540130	●
RFM 25 PP/TV	PTFE/FKM	10-D2540140	●
RFM 25 PP/EE	EPDM	10-D2540210	●
RFM 25 PP/VV	FKM	10-D2540310	●
RFM 25 PTFE/TK	PTFE/FFKM	10-D2500120	●
RFM 25 PTFE/TE	PTFE/EPDM	10-D2500130	●
RFM 25 PTFE/TV	PTFE/FKM	10-D2500140	●
RFM 25 PTFE/EE	EPDM	10-D2500210	●
RFM 25 PTFE/VV	FKM	10-D2500310	●



RFM -F25 in polypropylene (PP) for abrasive fluids, connection pump G 1" female, flap valve PUR

	diaphragm/seal	part no.	
RFM-F 25 PP/N/PUR	NBR/PUR	10-D2540510	●

RFM 25 in polytetrafluoroethylene (PTFE) FDA CFR 21 conform, connection pump G 1" female

	diaphragm/seal	part no.	
RFM 25 PTFE/TK (FDA)	PTFE/FFKM	10-D2500121	●
RFM 25 PTFE/TE (FDA)	PTFE/EPDM	10-D2500131	●



**RFML 25 electrically conductive PP or PTFE, for applications in Zone 1,
Ex-marking II 1/2 G Ex h IIB T6..T4 Ga/Gb, connection pump G 1" female**

	diaphragm/seal	part no.	
RFML 25 PP/NN	NBR	10-D2541010	●
RFML 25 PP/TK	PTFE/FFKM	10-D2541120	●
RFML 25 PP/TE	PTFE/EPDM	10-D2541130	●
RFML 25 PP/TV	PTFE/FKM	10-D2541140	●
RFML 25 PP/EE	EPDM	10-D2541210	●
RFML 25 PP/VV	FKM	10-D2541310	●
RFML 25 PTFE/TK	PTFE/FFKM	10-D2501120	●
RFML 25 PTFE/TE	PTFE/EPDM	10-D2501130	●
RFML 25 PTFE/TV	PTFE/FKM	10-D2501140	●
RFML 25 PTFE/EE	EPDM	10-D2501210	●
RFML 25 PTFE/VV	FKM	10-D2501310	●



RFM
FDM

RFML 25 electrically conductive PTFE, FDA CFR 21 conform

	diaphragm/seal	part no.	
RFML 25 PTFE/TK-FDA	PTFE/FFKM	10-D2501121	●
RFML 25 PTFE/TE-FDA	PTFE/EPDM	10-D2501131	●



Air-operated diaphragm pumps

RFM in solid construction

RFM 40 in polypropylene (PP) or polytetrafluoroethylene (PTFE) connection pump G ½" female

	diaphragm/seal	part no.	
RFM 40 PP/NN	NBR	10-D4040015	●
RFM 40 PP/TE	PTFE/EPDM	10-D4040135	●
RFM 40 PP/TV	PTFE/FKM	10-D4040145	●
RFM 40 PP/EE	EPDM	10-D4040215	●
RFM 40 PP/VV	FKM	10-D4040315	●

RFM 40 in polypropylene (PP) for abrasive fluids, connection pump G 1 ½" female, flap valve PUR

	diaphragm/seal	part no.	
RFM 40 PP/N/PUR	NBR/PUR	10-D4040510	●

RFM 40, in polytetrafluoroethylene (PTFE), connection pump G 1 ½" female

	diaphragm/seal	part no.	
RFM 40 PTFE/TK	PTFE/FFKM	10-D4000125	●
RFM 40 PTFE/TE	PTFE/EPDM	10-D4000135	●
RFM 40 PTFE/TV	PTFE/FKM	10-D4000145	●
RFM 40 PTFE/EE	EPDM/EPDM	10-D4000215	●
RFM 40 PTFE/VV	FKM/FKM	10-D4000315	●

RFM 40 in polytetrafluoroethylene (PTFE), FDA CFR 21 conform, connection pump G 1 ½" female

	diaphragm/seal	part no.	
RFM 40 PTFE/TK (FDA)	PTFE/FFKM	10-D4000121	●
RFM 40 PTFE/TE (FDA)	PTFE/EPDM	10-D4000131	●



Reduction nipple to connect the hose connections to the pump for:

- RFM 10**

material	connection	part no.	
PP	G 1" male - G 3/8" male	10-95906159	●
PVDF	G 1" male - G 3/8" male	10-95906169	●

- RFM 15**

material	connection	part no.	
PP	G 1" male - G 1/2" male	10-95906160	●
PVDF	G 1" male - G 1/2" male	10-95906170	●

- RFM 25**

material	connection	part no.	
PP	G 1 1/4" male - G 1" male	10-95906161	●
PVDF	G 1 1/4" male - G 1" male	10-95906171	●

- RFM 40**

material	connection	part no.	
PP	G 2" male - G 1 1/2" male	10-95906162	●



Hose connections for connection to the pump (reduction nipple is necessary):

- RFM 10/15**

material	connection	part no.	
PP	DN 13 - G 1" female	10-95904073	●
PVDF	DN 13 - G 1" female	10-95904177	●
PP	DN 19 - G 1" female	10-95904074	●
PVDF	DN 19 - G 1" female	10-95904178	●



- RFM 25**

material	connection	part no.	
PP	DN 25 - G 1 1/4" female	10-95904052	●
PVDF	DN 25 - G 1 1/4" female	10-95904102	●
PP	DN 32 - G 1 1/4" female	10-95904054	●
PVDF	DN 32 - G 1 1/4" female	10-95904103	●



- RFM 40**

material	connection	part no.	
PP	DN 32 - G 2" female	10-95904010	●
PVDF	DN 32 - G 2" female	10-95904084	●
PP	DN 38 - G 2" female	10-95904011	●
PVDF	DN 38 - G 2" female	10-95904085	●
PP	DN 50 - G 2" female	10-95904012	●

Suction tube for RFM 10, RFM 15 and RFM 25, polypropylene, with thread connector at the bottom G 1/2" male when outer Ø 20 mm, G 3/4" male when outer Ø 25 mm

	length	outer Ø	part no.	
with hose nozzle DN 13	1.000 mm	20 mm	10-95918021	●
with hose nozzle DN 25	700 mm	25 mm	10-95918008	●
	1.000 mm	25 mm	10-95918009	●
with thread connector G 1" male	700 mm	25 mm	10-95918010	●
	1.000 mm	25 mm	10-95918011	●
with thread connector G 1 1/4" male	1.000 mm	25 mm	10-95918013	●

Suction strainer

- for suction tube**

material	connection	outer Ø	part no.	
PP	G 1/2" female	20 mm	10-00110335	●
PP	G 1/2" female	25 mm	10-00110324	●



Accessories for air-operated diaphragm pumps

RFM/RFML

Pressure regulator with filter unit and speed control valve, complete (pre-mounted) for:

- **RFM** (for use in non hazardous areas)

	part no.	
RFM 10 (1/4")	10-D0100410	●
RFM 15/25 (1/4")	10-D0100412	●
RFM 40 (1/2")	10-D0100405	●

- **RFML** (for use in hazardous areas)

	part no.	
RFML 10	10-D0100320	●
RFML 15/25	10-D0100322	●



RFM 15 with pressure regulator

Stroke counter complete with 5/2-way control valve for RFM

	part no.	
RFM 10/15	10-D0100101	●
RFM 25	10-D0100102	●
RFM 40	10-D0100103	●

- **impulse cable**

	part no.	
for use with digital display, 5 m long	10-93408038	●

- **external digital display FLUXTRONIC®**

	part no.	
with mounting flange	10-00142113	●



RFM 15 with stroke counter, impulse cable and external digital display FLUXTRONIC®

Pulsation dampers, passive, max. operating pressure 8 bar:

for RFM 10 and RFM 15

	material	part no.	
PDP 15 PP/N	NBR	10-D0115400	●
PDP 15 PP/E	EPDM	10-D0115420	●
PDP 15 PP/V	FKM	10-D0115430	●

connector female thread 3/4" female

for RFM 25

	material	part no.	
PDP 25 PP/N	NBR	10-D0125400	●
PDP 25 PP/E	EPDM	10-D0125420	●
PDP 25 PP/V	FKM	10-D0125430	●

connector female thread 1" female

for RFM 40

	material	part no.	
PDP 40 PP/N	NBR	10-D0140400	●
PDP 40 PP/E	EPDM	10-D0140420	●
PDP 40 PP/V	FKM	10-D0140430	●

connector female thread 1" female



- **filling connection** for filling pulsation damper

material	connection	part no.	
brass	G 1/4" female - filling connection	10-D0100000	●

Air-operated diaphragm pumps

FDM/FDMH moulded pump design



FDM 07, pump connection 3/4" NPTF male, G 1/4" female 1/4" NPTF female

		housing	diaphragm	part no.	
FDM 07 PP/AA		PP	santoprene	10-M0740010	●
FDM 07 PP/TT		PP	PTFE	10-M0740100	●
FDM 07 AC/TT	Ex*	AC	PTFE	10-M0750000	●
				part no.	
adapter plate for replacement FDM 06 by FDM 07				10-M0770100	●



FDM 10, pump connection G 3/8" female

		housing	diaphragm	part no.	
FDM 10 PP/AA		PP	santoprene	10-M1040010	●
FDM 10 PP/TT		PP	PTFE	10-M1040110	●
FDM 10 AC/TT	Ex*	AC	PTFE	10-M1050110	●
FDM 10 PVDF/TT		PVDF	PTFE	10-M1060110	●



FDM 12, pump connection 1/2" NPT

		housing	diaphragm	part no.	
FDM 12 PP/AA		PP	santoprene	10-M1240210	●
FDM 12 PP/TT		PP	PTFE	10-M1240110	●
FDM 12 AC/TS	Ex*	AC	PTFE	10-M1250010	●
FDM 12 PVDF/TT		PVDF	PTFE	10-M1260010	●
FDM 12 AL/TT	Ex*	AL	PTFE	10-M1210100	●
FDM 12 AL/NN	Ex*	AL	NBR	10-M1210200	●
FDM 12 S/TT	Ex*	S	PTFE	10-M1220000	●

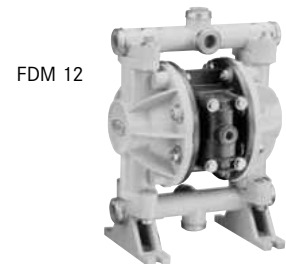

FDM 25, pump connection flange 1" (hose connection see page 84)

		housing	diaphragm	part no.	
FDM 25 PP/AA		PP	santoprene	10-M2540010	●
FDM 25 PP/CC		PP	PTFE	10-M2540050	●
FDM 25 PP/TT		PP	PTFE	10-M2540100	●
FDM 25 PVDF/TT		PVDF	PTFE	10-M2560000	●



FDM 25, pump connection G 1" female

		housing	diaphragm	part no.	
FDM 25 AL/NN	Ex*	AL	NBR	10-M2510000	●
FDM 25 AL/SS	Ex*	AL	PTFE	10-M2510300	●
FDM 25 AL/TT	Ex*	AL	PTFE	10-M2510100	●
FDM 25 S/TT	Ex*	S	PTFE	10-M2520100	●

FDM 40, pump connection flange 1 1/2" (hose connection see page 84)

		housing	diaphragm	part no.	
FDM 40 PP/AA		PP	santoprene	10-M4040010	●
FDM 40 PP/TT		PP	PTFE	10-M4040100	●
FDM 40 PVDF/TT		PVDF	PTFE	10-M4060000	●



FDM 40, pump connection G 1 1/2" female

		housing	diaphragm	part no.	
FDM 40 AL/NN	Ex*	AL	NBR	10-M4010000	●
FDM 40 AL/TT	Ex*	AL	PTFE	10-M4010100	●
FDM 40 S/TT	Ex*	S	PTFE	10-M4020100	●
FDM 40 GG/NN	Ex*	GG	NBR	10-M4030000	●

* for use in Zone 1, explosion-proof II 2 G D X



RFM
FDM

Air-operated diaphragm pumps

FDM/FDMH moulded pump design

FDM 50, pump connection flange 2" (hose connection see page 84)

		housing	diaphragm	part no.	
FDM 50 PP/AA		PP	santoprene	10-M5040010	●
FDM 50 PP/TT		PP	PTFE	10-M5040100	●
FDM 50 PVDF/TT		PVDF	PTFE	10-M5060000	●

FDM 50, pump connection G 2" female

		housing	diaphragm	part no.	
FDM 50 AL/NN	Ex*	AL	NBR	10-M5010200	●
FDM 50 AL/TT	Ex*	AL	PTFE	10-M5010300	●
FDM 50 S/TT	Ex*	S	PTFE	10-M5020300	●
FDM 50 GG/NN	Ex*	GG	NBR	10-M5030200	●
FDM 50 GG/TT	Ex*	GG	PTFE	10-M5030300	●

FDM 80, pump connection G 3" female

		housing	diaphragm	part no.	
FDM 80 AL/NN	Ex*	AL	NBR	10-M8010000	●
FDM 80 AL/TT	Ex*	AL	PTFE	10-M8010100	●
FDM 80 S/TT	Ex*	S	PTFE	10-M8020100	●
FDM 80 GG/TT	Ex*	GG	PTFE	10-M8030100	●

FDMH 25, pump connection G 1" female

		housing	diaphragm	part no.	
FDMH 25 S/TS	Ex*	S	PTFE	10-M2520200	●

* for use in Zone 1, explosion-proof II 2 G D X



Hose nipples for:

• FDM 07

material	connection	part no.	
MS	DN 10 - G ¼ male	10-95905022	●
PP	DN 10 - G ¼ male	10-95913128	●
PVC	DN 12 - G ¼ male	10-95905181	●

• FDM 10

material	connection	part no.	
PVC	DN 15 - G ⅜ male	10-95905232	●
MS	DN 13 - G ⅜ male	10-95905231	●

• FDM 12

material	connection	part no.	
PP	DN 13 - G ½ male	10-95905183	●
MS	DN 13 - G ½ male	10-95905017	●
MS	DN 19 - ½" NPT	10-95905247	●
S 316 Ti	DN 13 - ½" NPT	10-95905249	●
MS	DN 13 - ½" NPT	10-95905258	●

• FDM 25

material	connection	part no.	
PP	DN 25 - G 1" male	10-95905192	●
MS	DN 19 - G 1" male	10-95905161	●
MS	DN 25 - G 1" male	10-95905052	●
S 316 Ti	DN 25 - G 1" male	10-95905190	●

• FDM 40

material	connection	part no.	
MS	DN 38 - G 1½" male	10-95905185	●
MS	DN 32 - G 1½" male	10-95905186	●
S 316 Ti	DN 38 - G 1½" male	10-95905188	●

• FDM 50

material	connection	part no.	
MS	DN 38 - G 2" male	10-95905194	●



FDM 50



FDM 80



FDMH 25



Reduction nipples to connect the hose connections to the pump:

• FDM 07

material	connection	part no.	
MS	G ¼ male - G ½ male	10-95906091	●
MS	internal thread ¾ - 14 NPTi internal thread ½ - 14 NPTi	10-95906229	●

• FDM 10

material	connection	part no.	
PP	G 1" male - G ¾" male	10-95906159	●
PVDF	G 1" male - G ¾" male	10-95906169	●

• FDM 12

material	connection	part no.	
PP	½ NPT - G 1¼" male	10-95906078	●
PVDF	½ NPT - G 1¼" male	10-95906077	●
stainless steel 316 Ti	½ NPT - G 1¼" male	10-95906079	●

• FDM 25

	material	connection	part no.	
reduction nipple short	MS	G 1" male - G 1¼" male	10-95906080	●
	S 316 Ti	G 1" male - G 1¼" male	10-95906081	●
reduction nipple long	MS	G 1" male - G 1¼" male	10-95906082	●
	S 316 Ti	G 1" male - G 1¼" male	10-95906083	●



Hose connections for connection to the pump:

• FDM 07

material	connection	part no.	
S 316 Ti*	DN 13 - G ¾ female	10-95904133	●
S 316 Ti*	DN 19 - G ¾ female	10-95904147	●
PP	¾ - 14 A NPT	10-95913381	●

• FDM 10

material	connection	part no.	
PP	DN 13 - G 1" female	10-95904073	●
PP	DN 19 - G 1" female	10-95904074	●
PVDF	DN 13 - G 1" female	10-95904177	●
PVDF	DN 19 - G 1" female	10-95904178	●

* reduction nipple is necessary



Connection pieces for connection to the pump:

• FDM 12

material	connection	part no.	
MS	G ½" female - ½" NPT A male	10-95906112	●
S	G ½" A male - ½" NPT A male	10-95906119	●



Double nipples for:

• FDM 40

material	connection	part no.	
MS	G ½" male - G 1½" male	10-00118051	●
S 1.4436	G ½" male - G 1½" male	10-00118047	●



• FDM 50

material	connection	part no.	
MS	G 2" male - G 2" male	10-95906098	●
S 1.4436	G 2" male - G 2" male	10-95906099	●



Hoses for:

DN 9, outer Ø 12 mm

• FDM 07

material	pressure	part no.	
PE	max. 9 bar at 23°C	10-00110889	●

Accessories for air-operated diaphragm pumps

FDM

Hose connections for:

• FDM 12 and FDM 25

material	connection	part no.	
PP	DN 13 - G 1/4" female	10-95904081	●
PP	DN 19 - G 1/4" female	10-95904053	●
PP	DN 25 - G 1/4" female	10-95904052	●
PP	DN 32 - G 1/4" female	10-95904054	●
PVDF	DN 13 - G 1/4" female	10-95904082	●
PVDF	DN 19 - G 1/4" female	10-95904101	●
PVDF	DN 25 - G 1/4" female	10-95904102	●
PVDF	DN 32 - G 1/4" female	10-95904103	●
AL	DN 25 - G 1/4" female	10-95904119	●
AL	DN 32 - G 1/4" female	10-95904120	●
stainless steel 316 Ti	DN 19 - G 1/4" female	10-95904116	●
stainless steel 316 Ti	DN 32 - G 1/4" female	10-95904118	●



• FDM 40

material	connection	part no.	
stainless steel 316 Ti	DN 25 - G 1/2" female	10-95904002	●
stainless steel 316 Ti	DN 32 - G 1/2" female	10-95904003	●
stainless steel 316 Ti	DN 38 - G 1/2" female	10-95904004	●



• FDM 50

material	connection	part no.	
PP	DN 32 - G 2" female	10-95904010	●
PP	DN 38 - G 2" female	10-95904011	●
PP	DN 50 - G 2" female	10-95904012	●
PVDF	DN 32 - G 2" female	10-95904084	●
PVDF	DN 38 - G 2" female	10-95904085	●
stainless steel 316 Ti	DN 32 - G 2" female	10-95904059	●
stainless steel 316 Ti	DN 50 - G 2" female	10-95904009	●



Pulsation dampers for FDM 25, active

	housing	diaphragm	part no.	
PD 25 S/PTFE	S	PTFE	10-M0022500	●



Flanges complete with flat seal FKM and stainless steel screws (per pump two pieces are needed) for:

• FDM 25

material	connection	part no.	
PP	G 1/4" male	10-94714059	●
PVDF	G 1/4" male	10-94714060	●

• FDM 40

material	connection	part no.	
PP	G 2" male	10-94714061	●
PVDF	G 2" male	10-94714062	●

• FDM 50

material	connection	part no.	
PP	G 2" male	10-94714063	●



Hose connections for:

- FDM 12**

material	connection	outer Ø	part no.	
MS	DN 13 – G ½" female	21 mm	10-959 13179	●
MS	DN 13 – G ½" female	22 mm	10-959 13177	●
S	DN 13 – ½" male NPT	22 mm	10-959 13187	●



Brass and stainless steel hose connectors for hoses with DN 19, DN 25 and DN 32 see accessories for drum pumps on page 28

Suction tubes with 90° bend

- stainless steel 316 Ti**, with thread connector below G ¾" female

version	connection	length	outer Ø	part no.	
with thread connection G 1 male	G ¾"	1.000 mm	28 mm	10-959 18026	●
		1.200 mm	28 mm	10-959 18027	●
with thread connection G 1¼ male		1.000 mm	28 mm	10-959 18032	●
		1.200 mm	28 mm	10-959 18033	●

- stainless steel 316 Ti**, without thread connector on below

version	length	outer Ø	part no.	
with thread connection G 1½ male	1.000 mm	41 mm	10-959 18034	●
	1.200 mm	41 mm	10-959 18035	●



Suction tubes FDM 10, FDM 12 and FDM 25

- stainless steel 316 Ti**, thread connector below G ¾" female at Ø 18 mm, G ¾" female at Ø 28 mm

version	length	outer Ø	part no.	
with thread connection G ½" male	1.000 mm	18 mm	10-959 18017	●
with hose nozzle DN 25	1.000 mm	28 mm	10-959 18001	●
with thread connection G 1" male	1.000 mm	28 mm	10-959 18003	●
	1.200 mm	28 mm	10-959 18030	●
with thread connection G ¼" male	700 mm	28 mm	10-959 18004	●
	1.000 mm	28 mm	10-959 18005	●

- polypropylene**, thread connector below G ½" male at Ø 20 mm, G ¾" male at Ø 25 mm

version	length	outer Ø	part no.	
with hose nozzle DN 13	1.000 mm	20 mm	10-959 18021	●
with hose nozzle DN 25	700 mm	25 mm	10-959 18008	●
	1.000 mm	25 mm	10-959 18009	●
with thread connection G 1" male	700 mm	25 mm	10-959 18010	●
	1.000 mm	25 mm	10-959 18011	●
with thread connection G 1¼" male	1.000 mm	25 mm	10-959 18013	●



Suction strainer

- suction strainer** for suction tube

material	connection	outer Ø suction tube	part no.	
stainless steel AISI 304	G ¾" A, in plastic	28 mm	10-00110325	●
stainless steel AISI 304	G ¾" A, in plastic	18 mm	10-00110334	●
stainless steel, ex-proof	G ¾" A, in stainless steel	28 mm	10-00110357	●
stainless steel, ex-proof	G ¾" A, in stainless steel	18 mm	10-00110358	●
PP with flowback stop valve	G ½"	20 mm	10-00110335	●
PP with flowback stop valve	G ¾"	25 mm	10-00110324	●



earth wire with crocodile clip

	cable cross-section	length	forceps	part no.	
spiral cable (yellow)	3 mm²	4 m	stainless steel	10-93190023	●
cable (green/yellow)	4 mm²	2 m	steel zinc-plated	10-93190015	●



Hoses and hose clips see accessories for drum pumps on page 31-32

Accessories for air-operated diaphragm pumps

Further accessories for FDM

- **pressure regulator** for:

	connection	part no.	
FDM 10 / 12 / 15 / 25	G ¼" female	10-00110101	●
FDM 40 / 50 / 80	G ½" female	10-00110102	●



- **filter-regulator-lubricator unit** for:

	connection	part no.	
FDM 07 - FDM 25	G ¼" female	10-00110120	●
FDM 07 - FDM 25, explosion-proof	G ¼" female	10-00110150	●
FDM 40 / 50 / 80	G ½" female	10-00110160	●
FDM 40 - FDM 80, explosion-proof	G ½" female	10-00110117	●

- **double nipple** for the connection between filter-regulator and speed regulating valve for:

	connection	part no.	
FDM 07 - FDM 25	G ¼ A - G ¼ male	10-95906166	●
FDM 40 - FDM 80	G ½ A - G ½ male	10-95906167	●



- **speed regulation valve** for:

	connection	part no.	
FDM 07 - FDM 25	G ¼" female	10-D0100230	●
FDM 40 - FDM 80	G ½" female	10-D0100231	●



- **air connection** in brass (double nipple fixing) for:

	version	connection	part no.	
FDM 10 / 12 / 25	straight	¼" NPT - G ¼" male	10-95906088	●
FDM 40, FDM 50 PP/PVDF	straight	½" NPT - G ½" male	10-95906086	●
FDM 50 AL/S/GG, FDM 80 AL/S/GG	with 90° bend	¾" NPT - G ½" male	10-95906138	●



Further accessories for FDM and RFM

- **compressed-air hose**

nominal Ø, material	outer Ø	part no.	
DN 10, EPDM, electrically conductive	17.5 mm	10-00110913	●
DN 10, PVC	17 mm	10-00110071	●
DN 13, PVC	20 mm	10-00110008	●



- **coupling** in brass

nominal Ø	part no.	
DN 7,2 - G ¼" male	10-95913210	●



- **hose couplings** complete

consisting of threaded nipple and hose coupling

nominal Ø, material	part no.	
DN 10 - G ¼" male, brass	10-95913108	●
DN 13 - G ½" male, steel nickel-plated	10-95913109	●



- **plug-in sleeve** in brass for hose coupling

nominal Ø	part no.	
DN 10	10-95913209	●



- **hose nozzle** (brass)

nominal Ø	part no.	
DN 10 - G ¼" male	10-95905022	●
DN 13 - G ½" male	10-95905017	●



- **1-ear hose clip**

clamping range	part no.	
14,8 - 18,0 mm	10-95913237	●
18,8 - 22,0 mm	10-95913239	●



	part no.
individual certificate FOOD	10-Z0100400
individual certificate FDA	10-Z0100401
test certificate acc. to DIN EN 10204-2.2	10-95460577
inspection certificate for drum pump with commutator motor	10-95460526
inspection certificate for commutator motor	10-95460582
acceptance test certificate for progressive cavity pump with commutator motor, three-phase motor or compressed air motor	10-95460529
acceptance test certificate for centrifugal immersion pump with three-phase motor	10-95460527
calibration report FMC	10-95460768
calibration report FMO	10-95460750
certificate of origin	10-Z01000K3



More than just pumps

FLUX is a world renowned brand for the highest standards in pump technology. It all began in 1950 with the invention of the electric drum pump. Today, FLUX offers a wide range of products which can be configured individually. For example, FLUX pumps are used in the chemical and pharmaceutical industries, in machine and plant construction, as well as in electroplating, sewage treatment plants, and the food industry.

Whether as a stand-alone or a system solution, FLUX quality means long useful life, excellent economic efficiency and a maximum of safety.

Apart from the outstanding FLUX product quality and reliability, our clients appreciate the expertise and dedication of our employees to customer service.

Today, FLUX-GERÄTE GMBH supplies pumps to almost one hundred countries world wide.

FLUX-GERÄTE GMBH

Talweg 12 · D-75433 Maulbronn

Tel +49 7043 101-0 · Fax +49 7043 101-444

info@flux-pumpen.de · www.flux-pumps.com